

COVERS



416 Wireless control

417 Underwater Roussillon platform

418 Octeo

419 Sveltea

420 Manual Sveltea

421 Bellasun

422 Mobile Bellasun

423 BUBBLE COVER SELECTION GUIDE

425 THERMAL COVERS

426 Thermal Foam Sheet

427 Foam Sheet

428 Foam Sheet Rolls¹

COVER CONNECT

WIRELESS CONTROL FOR AUTOMATIC POOL COVER



Application with Bluetooth wireless control.

Easy to install and use.

Compatible with all underwater and above-ground automatic hatches*



2
YEAR
WARRANTY

MADE IN
FRANCE

* Not compatible with solar-powered retraction systems.

AUTOMATIC POOL COVERS

Underwater pool covers

Roussillon underwater model



EXPLANATION

Roussillon automatic pool covers are available in 3 different types to suit various pool needs.

Dry Engine: This model has its engine in a separate dry compartment below the water level, and both the winding shaft and the shroud are positioned inside the pool at one end.

Tube Motor: The motor is integrated into the winding shaft of the motor cover and can be installed in pre-built pools up to 8 meters wide. It is applicable to pools up to 8 x 12 m.

Water level motor: Specifically designed for newly constructed or existing pools up to 6 meters wide. The IP68 motor (waterproof) is located above the water level and below the cover.

In all models, the section containing the pool cover and shaft must be separated from the main pool by a curtain during construction or by a PVC partition (sold separately) afterwards.

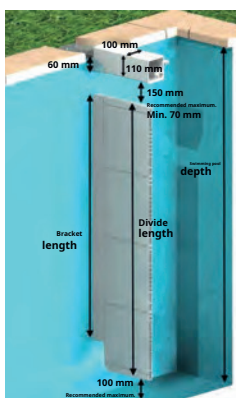

	Pool Dimensions	Code	Standard PACKAGING	Standard A 1r1k kg	Standard Volume m ³	Unit Price Euro
Roussillon underwater model	3 x 6 m	-	-	-	-	15,850.00
Roussillon underwater model	4 x 8 m	-	-	-	-	17,535.00
Roussillon underwater model	5 x 10 m	-	-	-	-	19,760.00
Roussillon underwater model	6 x 12 m	-	-	-	-	23,100.00

ROUSSILLON DRY MODEL ENGINE MODEL ASSEMBLY

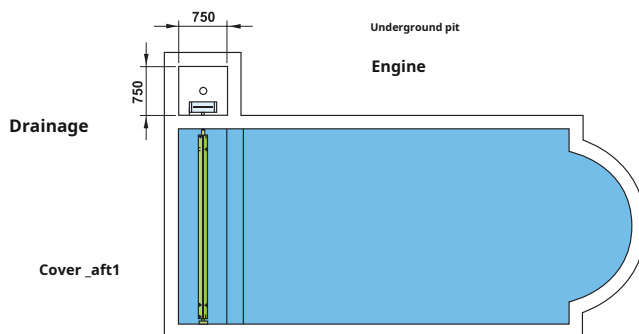
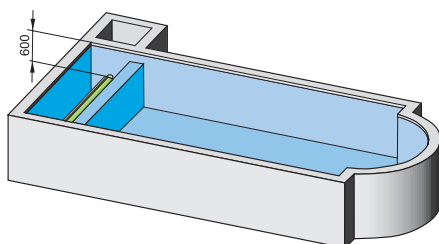
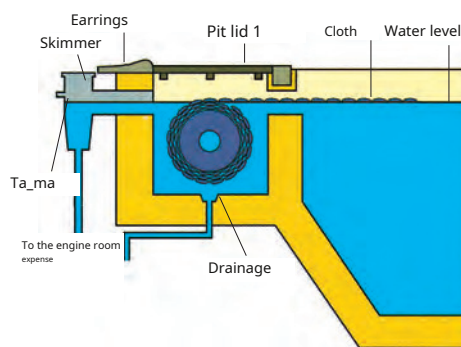

AUTOMATIC POOL COVERS

Ground-mounted models

Octeo_{model}



LAMA

Choose the combination option i.
 A new design with modern shapes and outlines..
 ee ba l1 Solar LED Lighting is available with white or grey base.
aluminum casting.
 Lay assembly / disassembly

- Motor: Tubular type.
- Pool (internal dimensions): 7.5 x 17 m
- Motorized aft
 - With limit switch.
 - Disinfection mode.
- Standard foot.
- 4 legs in 1 different color.



**White / White
BB**

**White / Anthracite
BG**

**Anthracite / White
GB**

**Anthracite / Anthracite
GG**

	Pool Dimensions	Code	Standard PACKAGING	Standard Weight (kg)	Standard Volume m ³	Unit Price Euro
OCTEO above ground	4 x 8 m	-	-	-	-	8,100.00
OCTEO above ground	4 x 10 m	-	-	-	-	8,800.00
OCTEO above ground	5 x 10 m	-	-	-	-	11,100.00
OCTEO above ground	6 x 12 m	-	-	-	-	15,250.00
OCTEO above ground	7 x 14 m	-	-	-	-	19,800.00

* Please inquire about prices for other sizes.

- Notes:
- - Cover Connect mobile app
- - Remote control panel + mobile app
- - For remote control switch1 and mobile application optional features, please contact us.



+



AUTOMATIC POOL COVERS

Ground-mounted models

Svelteamodel



EXPLANATION

- There are 4 color combination options.
- Ca da_tasar1m.
- Tubular engine.
- Minimized footprint.
- Easy assembly/disassembly

- Motor: Tubular type.
- Pool (internal dimensions): 5 x 10 m
- Motorized aft
 - With limit switch.
 - Cover mode integrated with disinfection system.
- Optional Cover Connect.
- 4 legs in 1 different color.



Energy Productive



White / White
BB

White / Anthracite
BGA

Gray / White
BGC

Turquoise / White
BBT

	Pool Dimensions	Code	Standard PACKAGING	Standard Weight (kg)	Standard Volume m3	Unit Price Euro
SVELTA above-ground	4 x 8 m	-	-	-	-	7,490.00
SVELTA above-ground	4 x 10 m	-	-	-	-	8,380.00
SVELTA above-ground	5 x 10 m	-	-	-	-	9,300.00

* Please inquire about prices for other sizes.

- Notes:
- - Cover Connect mobile app
- - Remote control panel + mobile app
- - For remote control switch¹ and mobile application optional features, please contact us.



AUTOMATIC POOL COVERS

MANUAL SVELTEA



Pool (internal dimensions):
Up to 4 x 10 m²
Up to 5 x 8 m²



Retraction:
manual



Stands:



- + 4 colors
- + _1k design1m
- + Compact size
- + Easy to install

Pool Dimensions ¹	Coil Ø (mm) (mil + t1talar)	Unit Price Euro
4 m x 8 m	350	5,800.00
4 m x 10 m	380	6,600.00
5 m x 10 m	410	7,500.00

TECHNICAL DIAGRAMS

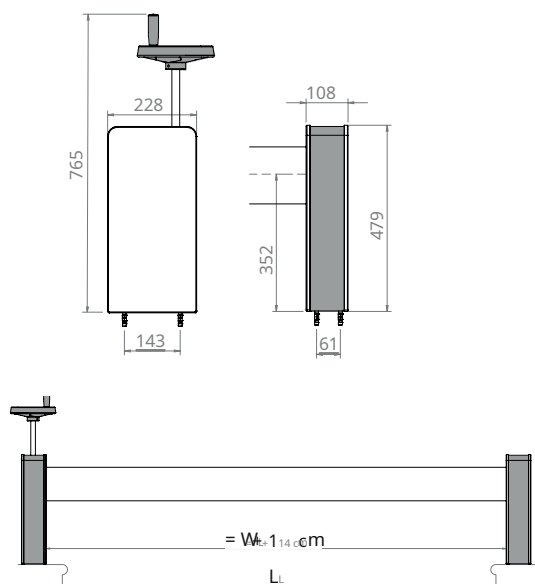

AUTOMATIC POOL COVERS

Ground-mounted models

Bellasun_{model}



Engine



Battery and solar panel



EXPLANATION

- New generation stand. Aesthetically pleasing integration with the pool area thanks to its "Full Black" solar panel.
- Ideal for existing pools: easy installation, no electrical connection required.
- 1 charge has a capacity of 20 on/off cycles.
- Battery charge protection regulator.
- Detachable motor.
- Motor: Tubular type.
- Pool (internal dimensions): 6.03 x 12 m
- Solar powered drum
- With limit switch.
- Anodized aluminum, _aft Ø 146 mm or Ø 196 mm.
- Stands made of galvanized aluminum for optimum corrosion resistance.



	Pool Dimensions	Code	Standard PACKAGING	Standard Weight (kg)	Standard Volume m ³	Unit Price Euro
BELLASUN above ground	4 x 8 m	-	-	-	-	11,800.00
BELLASUN above ground	4 x 10 m	-	-	-	-	13,250.00
BELLASUN above ground	5 x 10 m	-	-	-	-	14,800.00
BELLASUN above ground	6 x 12 m	-	-	-	-	16,600.00

* Please Inquire about prices for other sizes.

- Notes:
- - Cover Connect mobile app
- - Remote control panel + mobile app
- - For remote control switch1 and mobile application optional features, please contact us.



MOB1L BELLASUN ON THE RAILS



5
YEAR WARRANTY
ENGINE

2
YEAR WARRANTY
WARRANTY

1
YEAR WARRANTY
BATTERY

Energy
Efficient

Water
Conservation

 **Tubular Engine**

 Pool (internal dimensions):
Up to 5.03 x 12 m

 **Retraction:**
thanks to the solar panel
completely away from the pool

 **Stands:**
Rilsan® coated aluminum & stainless steel

FOOT SWITCH

 **ATTENTION**
Sun_panel sun_1_1 1na
It should be kept away from
exposed and shaded areas.









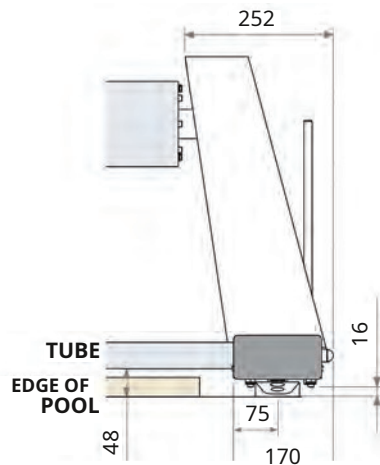
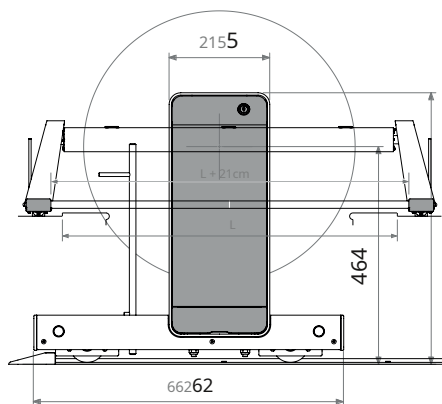
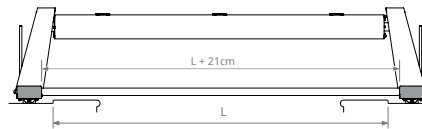
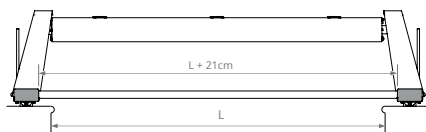

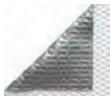

- + Mobile retractable system on rails for covering standard d1_1 pool shapes and clearing the area around the pool.
- + + Autonomous model powered by solar panel
- + Easy to install, no power connection required.
- + _arj1 battery autonomy = 20 on/off cycles
- + Charge regulator that protects the battery from deep discharges.
- + Circuit d1_1 can be left on motor

TECHNICAL DIAGRAMS

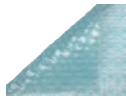
If the rails are mounted on the edge of the pool or if there is no edge to the pool



BUBBLE COVER SELECTION GUIDE

	BUBBLE COVER 400µ		BUBBLE COVER 500µ		
					
	Bleu/bleu	OXO 400 HEAT	RaeGuard™	EnergyGuard	Left+Guard
3 ENVIRONMENT	I am surrounded		Couple		Luxury
					
Brand					
Secure	✗	✓	✓		✓
Water 1s1s1n1 art1r1c1	Between +3°C and +4°C	+7°C	Opaque and sun-proof. Is1tma1 for pools It is designed. It keeps the heat and It maintains the water temperature.	+7°C	+7°C
Prevents algae growth.	-		✓	✓	-
Reduction in energy consumption*	69%	121%	57%	60%	70%
Chemical products decrease in usage*	-	40%	50%	60%	40%
Reduce1lm1_filtration Filtering time*.	-		-	50%	-
Suitable for use with K1_cover.	✗	✗	✗	✓	✗
Eliminates water evaporation.	98%	98%	98%	98%	98%
Reduction of pollution caused by residues	✓	✓	✓	✓	✓
Reduction in the carbon footprint created by the pool*.	✓	✓	✓	✓	✓
Guarantee	3 years	4 years	8 years	8 years	8 years

* The technical data shown in this summary table was provided by the material manufacturer, Fluidra Industry France. It is provided for informational purposes only and on the condition that the isothermal blanket is used in accordance with the given instructions.

WARRANTY COVERS:



- ✓ **Manufacturing and material defects1**
Holes, tears, and rips discovered upon receipt of the product (unpacking) are only covered if these defects are due to damage sustained during transport. In this specific case, the customer must clearly state their concerns so that we can assume responsibility for the transportation dispute.

NOT COVERED BY WARRANTY:

- ✗ **Color fastness and dimensional stability.**
- ✗ **Damage to the cover due to chlorination and wear.**
- ✗ **Removal and reinstallation costs.**

BUBBLE COVER SELECTION TABLE

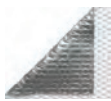
ABOVE WATER ROUSSILLON LATHE PAVING

	BUBBLE 400 μ	BUBBLE 500 μ		
				
	Bleu/bleu	RaeGuard™	EnergyGuard	Left+Guard
3 bits_	Non-bordered	Duo		Luxury
				
Brand				
Secure	✗	✓		✓
It increases the water temperature.	between +3°C and +4°C	for pools It has been designed. Is1y1 amount and It maintains the water temperature.		+7°C
Prevents algae growth.	-	✓	✓	-
Reduction in energy consumption*	-	57%	60%	70%
Chemical products decrease in usage*	-	50%	60%	40%
Reduced filtration	-	-	50%	-
Suitable for use as a K1 cover.	✗	✗	✓	✗
Reduction of pollution caused by residues	-	98%	98%	98%
It eliminates water evaporation*.	✓	✓	✓	✓
Reducing the carbon footprint created by the pool.	✓	✓	✓	✓

THERMAL AND PROTECTIVE COVERS

Thermal blanket - Bubble

Bubble

Bubble floating thermal blanket



Blue-blue bubble



DUO



LUXE

EXPLANATION

- **Material structure** :Polyethylene-based
- **Additional** material. :Ultrasonic welding.
- **Edges NB model** :The cut is without melting.
- **Edges Duo model** :Short edges stitched polyethylene strip.
- **Deluxe model on the edges** :Fully (4-sided) stitched polyethylene strip. :
- **Ba lant1 halkalar1** Duo model with rings on the edges
Deluxe model has one ring every 65 cm. :Nickel-plated brass.
- **Ring material** :Nickel-plated brass.
- **PACKAGING** :It comes with protective packaging and an instruction manual.
- **Thickness** :400µm.

Model	Pool Dimensions	Code Standard Package	Standard a 1r11k kg	Standard volume m ³	Unit PriceEURO
Borderless	4x8	Custom made -	-	-	544.00
Borderless	5x10	Custom Made -	-	-	1,055.00
Borderless	6x12	Custom Made -	-	-	2,535.00
DUO Blue	4 x 8m	Custom Made -	-	-	634.00
DUO Blue	5 x 10m	Custom Made -	-	-	991.00
DUO Blue	6 x 12m	Custom Made -	-	-	1,428.00
Luxe Blue	4 x 8m	Custom Made -	-	-	676.00
Luxe Blue	5 x 10m	Custom Made -	-	-	1,055.00
Luxe Blue	6 x 12m	Custom Made -	-	-	1,520.00

Energy Guard

EXPLANATION

The aim of our Guard high-performance material is to deliver the highest performance in its specific functions for the longest possible service life.

EnergyGuard# Selective Transmission has an expected lifespan of 8 years in residential pools. UV protection is formulated to ensure the materials withstand exposure to the harsh pool environment. To ensure the product's longevity, we continuously test it on our own accelerated weather resistance testing machine. Our own laboratory tests are supported by feedback from customers around the world.

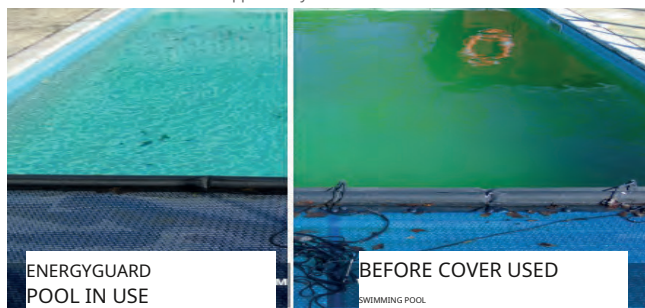

Model	Pool Dimensions	Code Standard Package	Standard a 1r11k kg	Standard volume m ³	Unit PriceEURO
Borderless	4x8	Custom made -	-	-	LFS
Borderless	5x10	Custom Made -	-	-	LFS
Borderless	6x12	Custom Made -	-	-	LFS
DUO Blue	4 x 8m	Custom Made -	-	-	LFS
DUO Blue	5 x 10m	Custom Made -	-	-	LFS
DUO Blue	6 x 12m	Custom Made -	-	-	LFS
Luxe Blue	4 x 8m	Custom Made -	-	-	LFS
Luxe Blue	5 x 10m	Custom Made -	-	-	LFS
Luxe Blue	6 x 12m	Custom Made -	-	-	LFS

Thermal foam blanket

5 mm thermal foam cover



FOAM



EXPLANATION

- **Material structure** :Cross-linked polyethylene foam based material. : Thermal welding with double-sided polyethylene tape. : Sewn PVC strip.
- **Additional Edges** :Short edges stitched PVC strip : 4-Edge PVC Strip
- **DUO model** :Duo model with rings on the edge
- **Luxury model** :Deluxe model has one ring every 65 cm. :Nickel-plated brass.
- **Ring material** :K1sa edge-mounted polyethylene foam floating reinforcement. :It is delivered wrapped in a protective case. :5 mm.
- **Optional**
- **PACKAGING**
- **Thickness**

Model	Pool Dimensions	Code Standard Package	Standard a 1r1k kg	Standard volume m3	Unit Price Euro
DUO 5mm foam cover	4 x 8m	Custom Made	-	-	1,896.00
DUO 5mm foam cover	5 x 10m	Custom Made	-	-	2,960.00
DUO 5mm foam cover	6 x 12m	Custom Made	-	-	4,100.00
Luxe 5mm foam sheet	4 x 8m	Custom Made	-	-	2,350.00
Luxe 5mm foam sheet	5 x 10m	Custom Made	-	-	3,500.00
Luxe 5mm foam sheet	6 x 12m	Custom Made	-	-	4,890.00

BUBBLE COVERS SHAFT SYSTEMS

Plus_canker sores



Telescopic pipe ø 100 mm for pools up to 12 x 6 m (72 m2).
Stainless steel "T" legs

- 1 wheeled and with brakes

- 1 constant

"Clip-on 9 or 11 straps for securing the cover as a whole."

Fixed pipe_canker sores



The shaft system includes the following:

1 fixed central pipe " 1 movable

support

Fixed pipe_canker sores	No. of straps		Code	Unit PriceEURO
4.50 m	9	FI20F	078065	LFS
5.50 m	11	FI20F	078066	LFS
6.50 m	13	FI20F	078067	LFS

ECO-ROLL Roller	Maximum dimensions Width x Length	Code Roll	Code Engine kit	Unit PriceEURO	
Ø d1_center tube 75.9 mm	4 x 9 m	FI20F	078031	078031MOT	LFS
Ø d1_center tube 91.6 mm	5 x 11 m	FI20F	078032	078032MOT	LFS
Ø d1_center tube 112 mm**	7 x 14 m	FI20F	078033	078033MOT	LFS

FOAM COVER

EXPLANATION



Minimum producible size: 10 m²

"Thickness 6 mm"

"Color: Blue / Blue" 2

types of coating:

"Duo: 2 width borders" "Luxe:

borders along the perimeter"

"This sheet is considered the most effective and durable sheet in the isothermal category. Foam sheet is ideal for:

- public swimming pools
- spas

+ Keeps water temperature

+ Prevents water from evaporating.

28°c
MAX



- + Prevents excessive use of the dehumidifier.
- + Excellent chlorine stability

Bits

DUO



PVC tape reinforcement sewn onto both sides. Stainless steel rings for wrapping straps approximately every 60 cm. One ring at each corner. Maximum width 6 m, beyond which the cover consists of several parts.

LUXE



PVC tape reinforcement sewn around the perimeter. Stainless steel rings for wrapping straps approximately every 60 cm. One ring at each corner. Maximum width 6 m, beyond this the cover is made in several pieces.

Foam Sheet

BLEU / BLEU STANDARD	Figure Standard d1_1		Freeform		Figure	
	Code	Unit Price EURO/m ²	Code	Unit Price EURO/m ²	Code	Unit Price EURO/m ²
BITI_LER						
Duo	074995	LFS	075000	LFS	075002	LFS
Luxury	075009	LFS	075010	LFS	075012	LFS

Stairs

Stairs		Code	Unit Price EURO
Stairs CARRÉ	FI22F	079820	LFS
Stairs NOVEL	FI22F	079821	LFS
Other Stairs	FI22F	079822	LFS
Staircase Cutting	FI22F	079801	LFS



FOAM COVERS 1N ROLL SYSTEMS

- + Mobile winding machines with stainless steel supports
- + Easy assembly, delivered disassembled.
- + Anodized aluminum axles
- + The axles were cut to size and adjusted according to the width of the shaft.
- + 3-year warranty on motor & box.



SINGLE AXIS MANUAL MOBILE WINDING MACHINE

- "Hand-installed"
- "Mobile"
- "Brake system and axis locking mechanism"

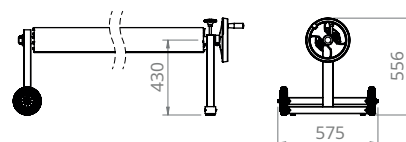

	Max Length	Code	Unit Price Euro
Foam	7 x 10 m	070675	2,200.00
Bubble	7 x 15 m	070675	2,200.00
Bubbles and Foam	7.5 x 20 m	070677	2,600.00

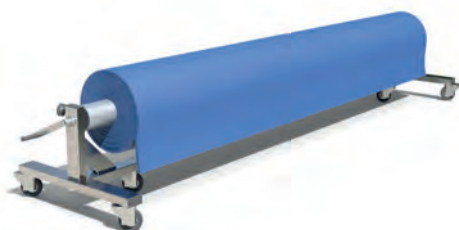

3-legged SINGLE AXIS MANUAL MOBILE WINDING MACHINE

- "Hand-installed"
- "6 multi-directional wheels with brakes"
- "Brake and axle locking system"

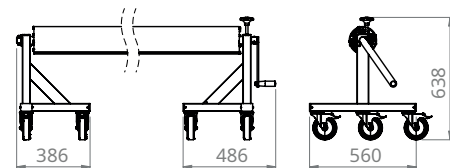

Max Length	Code	Unit Price Euro
8 x 25 m	070681	7,900.00

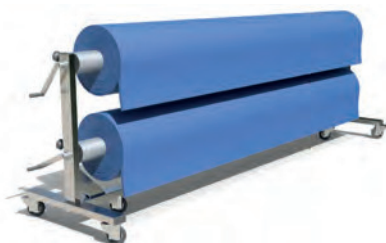

MANUAL DOUBLE AXIS MOBILE YELLOW

- "Hand-installed"
- "6 multi-directional wheels with brakes"
- "Brake and axle locking system"

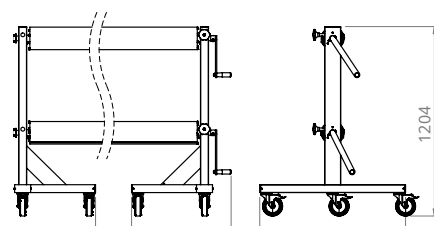

Max Length	Code	Unit Price Euro
16 x 25 m (2 x 8 m)	070684	7.240.00

MOTORIZED SINGLE-AXIS MOBILE WINDING MACHINE

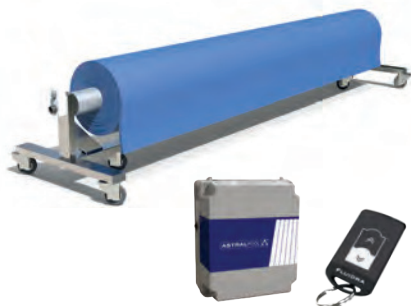

"6 multi-directional wheels with brakes" 10 m extension cable. "Key lock on the support." "It is supplied with a box and remote control."

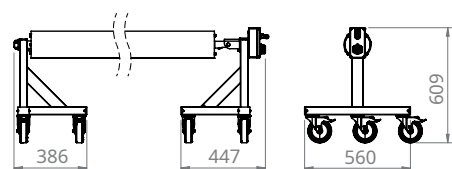

Max Length	Code	Unit Price Euro
8 x 25 m	070687	9,600.00

MOTORIZED DOUBLE-AXIS MOBILE WINDING MACHINE

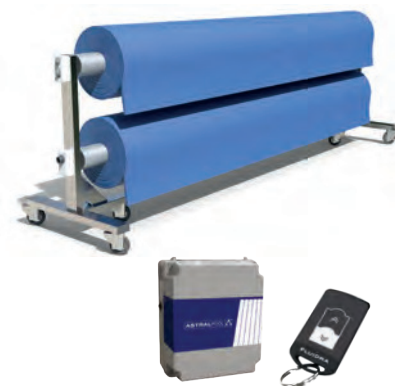

6 multi-directional wheels with brakes " 10 m extension .
"Key lock on the support."
"The remote control and box are included."

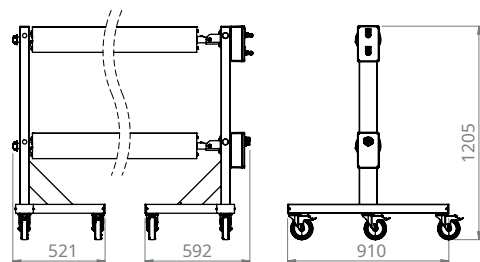

Max Length	Code	Unit Price Euro
16 x 25 m (2 x 8 m)	070692	15,900.00

MOTORIZED KITS

• Kits for converting pulley "tripod" guides into motorized retractors.

- A 10 m extension cable is included.
- Power supply box and remote control are included.

	Code	Unit Price Euro
WHEELED SINGLE AXLE THREE-LEGGED 1CHIN	070690	LFS
WHEELED SINGLE AXLE THREE-LEGGED 1CHIN	070694	LFS

TERMINAL TYPE CYLINDER

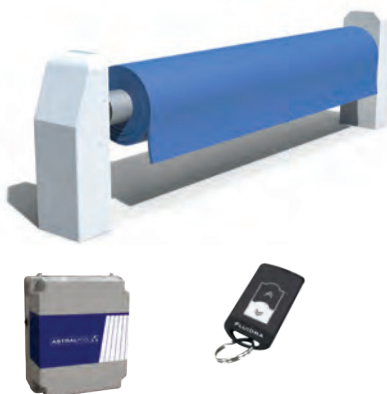

" Motorized windshield
Aluminum support
"Remote control"
"Box and remote control are provided."

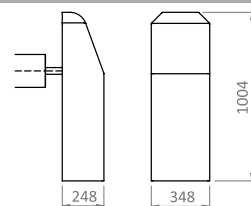

Max Length	Code	Unit Price Euro
11.5 x 25 m	060719	28,800.00

ADDITIONAL INFORMATION

- The distance between the cover and the edge of the pool should be kept as short as possible to prevent the cover from wearing down due to friction.
- Shipping costs are quoted upon request.
 - We can adapt our pulley system to suit your projects.

