

SWIMMING POOLS



534 OLIMPIC POOL EQUIPMENT

534 Movable wall system

535 Sparger - Safety system for diving pools1

536 OLIMPIC POOL DIVING PLATFORMS

536 Jumping podium

537 Jumping platform AISI-316 AISI

537 304 Jumping platforms1

539 Velocity advantage, Diving platform,

539 Backstroke Swimming Training System,

539 Backstroke Swimming Start System

540 Elevation platforms for podiums1

540 Podium anchors1

541 SEPARATORS

541 Sydney model separator

541 Roman model

541 Moscow model

542 SEPARATOR STORAGE EQUIPMENT

543 SEPARATOR ACCESSORIES

545 HALF-PONDS 1 GOOSE SETS 1

546 TURNING PANELS 1

546 ANCHORS

547 WATER POLO CASTLE 1

Developed by Fluidra, Bulkhead, a movable bridge, enhances the possibilities of a pool by dividing it into different areas and providing varying sizes, depths, and uses. This increases the profitability of the available space and saves on construction costs associated with building different aquatic facilities.



NEW
2023

MOVABLE BULKHEAD

SRSmith.

Bulkhead is a vertical underwater bridge that can move longitudinally along the pool floor to create a physical barrier, dividing the pool into areas for different uses, thus making the best use of the space in the pool.

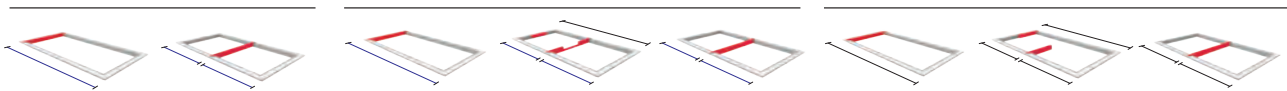

Benefits:

- Easily integrated solution, compliant with FINA standards, fast assembly.
- 1_Value added for businesses. Easy to use.
- Dayan1kl1
- Low maintenance requirements

MOVABLE WALL

SRSmith.

The movable wall is installed at a fixed point on the pool floor where the pool will be divided in two. When not in use, the wall is completely flat in a recess in the pool floor. In a newly constructed swimming pool, the wall is integrated into a structural recess so that it is invisible when not in use.

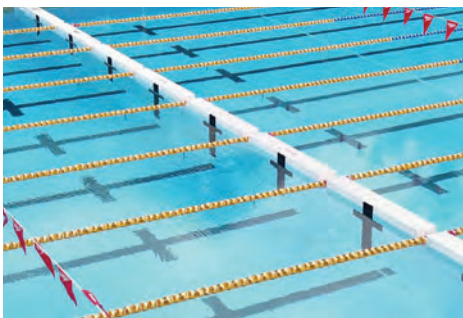

Benefits:

- H1z11 setup
- 1_Value added for businesses. Easy to use.
- Dayan1kl1
- Low maintenance requirements

MOVABLE FLOOR

The Movable Pool Floor makes it possible to use a single swimming pool to accommodate several activities requiring different water depths simultaneously. The system is based on a submerged mobile platform that changes the height of the pool shell, allowing for the creation of areas with varying depths as needed. Additionally, the movable pool floor can be used to partially or completely enclose a pool, resulting in greater energy savings and safety.



Benefits:

- Easily integrated solution H1z11 assembly
- 1_Value added for businesses. Easy to use.
- Dayan1kl1
- Hygienic
- Trustworthy

SPARGER- Safety system for diving pools¹

When jumping from a diving board, the undisturbed surface creates a highly resistant surface, and this, combined with a poor landing, can cause serious injury upon impact.

AstralPool has added Sparger technology to its pools as a new safety system for diving pools. Air is released from the pool bottom under high pressure, creating a large number of bubbles when it mixes with the water to form a cushion for divers. This reduces the risk of injury and makes diving safer for both beginners and professional divers.

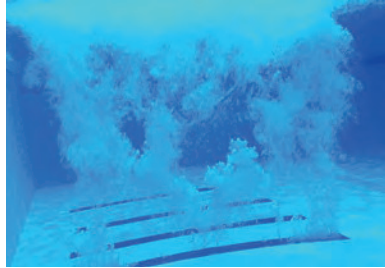

OLIMPIC POOL FORMATION

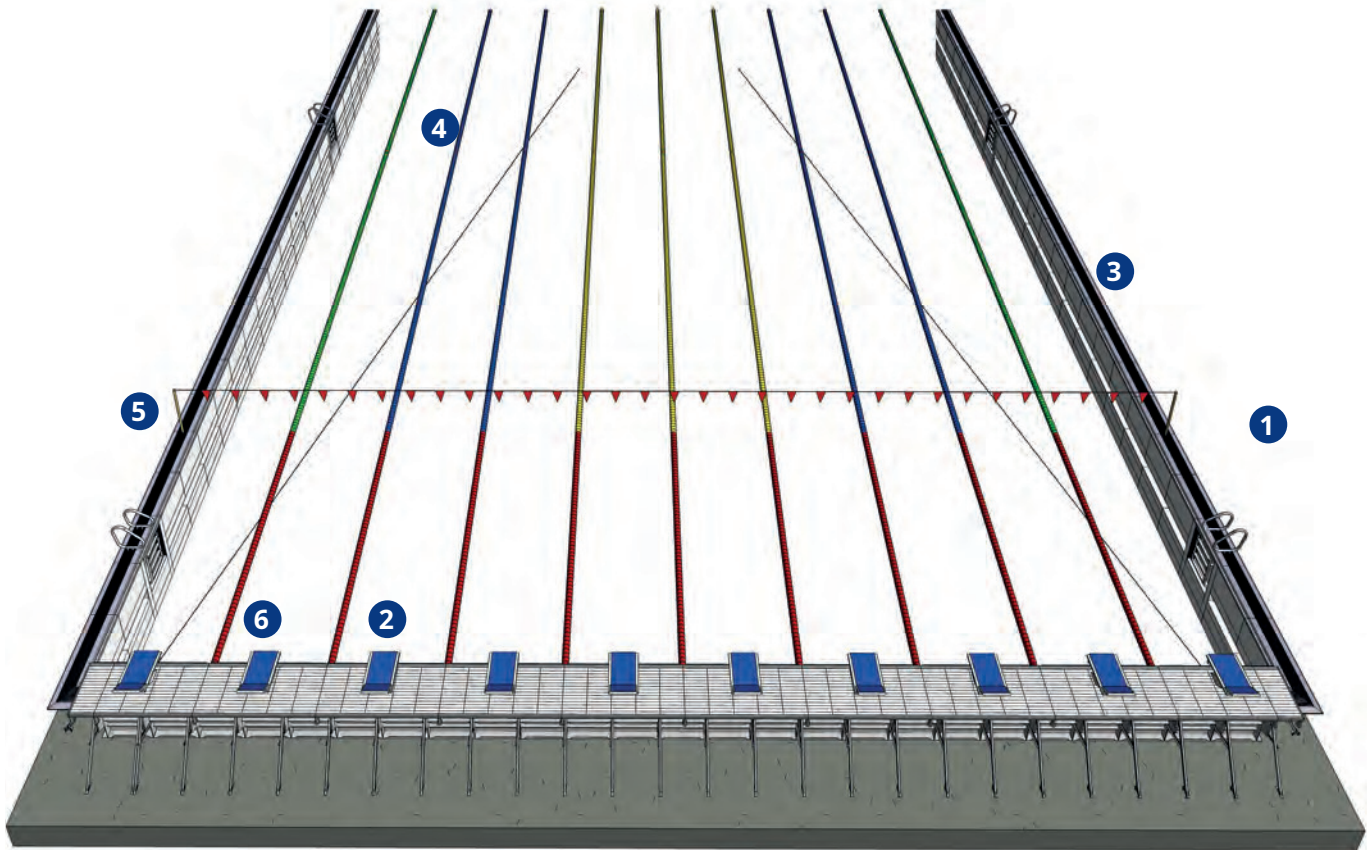

- ① Stairs
- ② Jumping platform
- ③ Ta_ma channel 1grills1

- ④ Lane separators
- ⑤ Return warning kit.
- ⑥ Supported return panels.

OLIMPIC POOL DIVING PLATFORMS

JUMPING PODIUM



It is specially designed for semi-skilled use. It has an adjustable footrest surface for the starting position.

The minimalist design and high-quality materials give it a modern and elegant look.

Manufactured from AISI-316 polished stainless steel. Features an adjustable footrest (6 positions). Anchor code 54460 is not included.



EN 13451-4
Compliant with standards

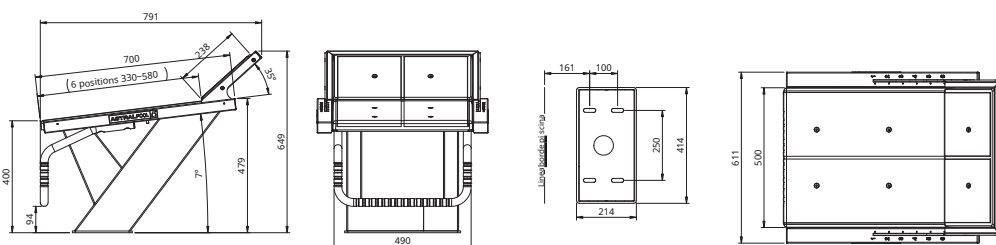

	Code	Standard PACKAGING	Standard weight kg	Standard Volume m ³	Unit Price Euro
Jumping podium	53875	1	-	-	5,500.00

JUMPING PODIUM H-700mobile support



It is FINA compliant and specifically designed for UNE EN 13451-4 competition. It has a 6-position adjustable support to facilitate the swimmer's exit. It is made of AISI-316 stainless steel and has a height of 700 mm. Anchor 73971 is not included with the yachts.



EN 13451-4
Compliant with standards



FINA Standards
suitable

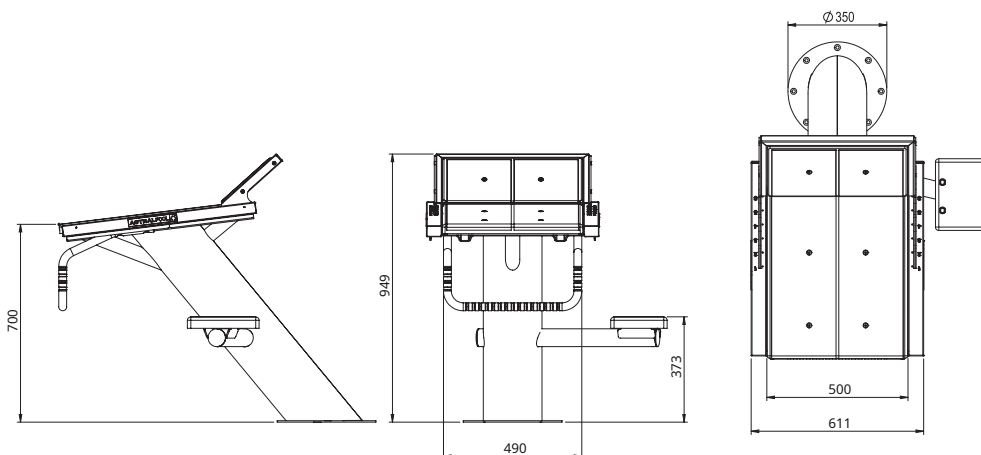

	Code	Standard PACKAGING	Standard weight kg	Standard Volume m ³	Unit Price Euro
Jumping platform H-700	74011	1	110	-	6,800.00

JUMPING PODIUM H-700anchor



The 74011 code H-700 anchor is designed for podiums and is intended to be embedded in concrete. It is made of stainless steel AISI-316L.

	Code	Standard PACKAGING	Standard weight kg	Standard Volume m ³	Unit Price Euro
Jumping platform H-700 anchor	73971	1	8.42	-	380.00

OLIMPIC POOL DIVING PLATFORMS

AISI-316 SKI JUMPING PODIUMS

Non-slip, bergère glass and polyester platform, blue in color, 500x500 cm. It sits on a body made of AISI-316 steel. Anchor connections (code 54461) and numbers are not included.



	Code	Standard PACKAGING	Standard weight kg	Standard Volume m ³	Unit Price Euro
Polished surface					
Height 700 mm	00144	1	32.0	0.36	2,700.00
Height 400 mm	00145	1	25.3	0.18	2,150.00

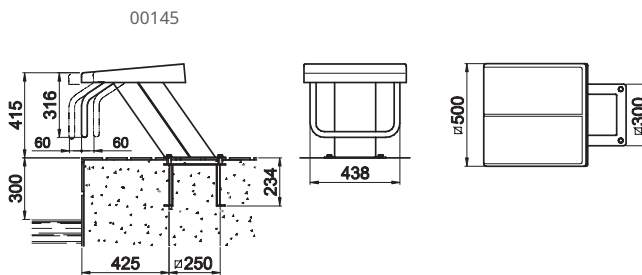
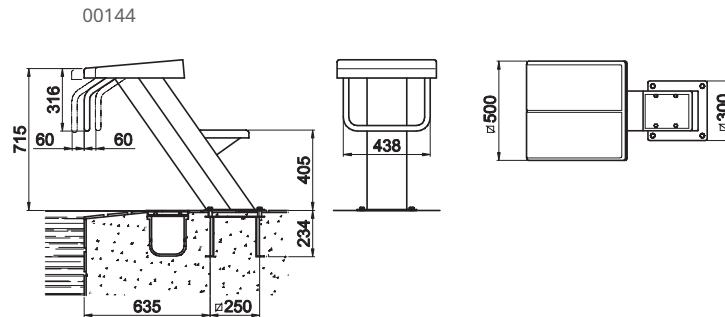

AISI-304 SKI JUMPING PODIUMS

A blue, non-slip platform made of 500 x 500 bergère glass and polyester, sitting on top of a body made of AISI-304 stainless steel (numbers not included).



	Code	Standard PACKAGING	Standard weight kg	Standard Volume m ³	Unit Price Euro
Polished surface					
Height 700 mm	00146	1	25.0	0.48	1,550.00
Height 400 mm	27578	1	18.0	0.11	1,450.00

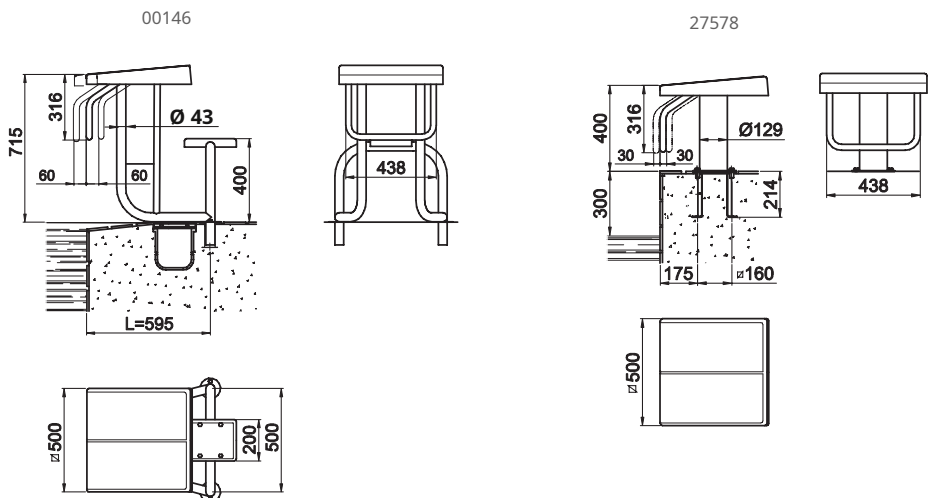

Note: Code number 00146 the jumping platform, ta_ma channels to adapt to the situation It can be done for. In situations like these, The dimensions for L must be provided.

Notes: Code 00146: Connection anchor (code 00143), not included. Code 27578: Connection anchor (code 54462), not included.



OLIMPIC POOL DIVING PLATFORMS



VELOCITY ADVANTAGE Jumping podium



The Velocity Advantage diving platform features reinforced berglas steps with starting position footrests on an HDPE composite base. It is compatible with our Bulkheads movable pool systems.

- Marine-grade HDPE composite flooring is easily mounted to pool decks or bulkheads with minimal drilling.
- With a height of 41 cm, it is very suitable for curtains and balustrades that are 20 cm to 42 cm above the water.
- The 71cm x 81cm step surface is available in TrueTread® or sand-backed finish.
- The footrest's starting block, adjustable to 5 positions, easily folds under the footrest.
- Three integrated supine handles – two in the center position and one on each side.
- Colorado & Daktronics timing system is compatible.
- The non-slip steps feature custom colors and logos.
- Complies with FINA, NCAA, NFSHSA*, USMS and USAS semi-final pool rules and regulations.

TrueTread color options:

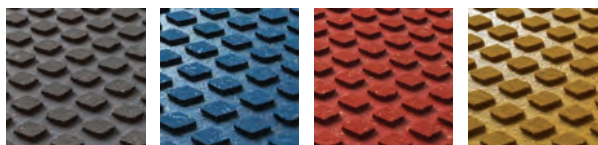

GRAY

BLUE

RED

YELLOW



Non-slip surface color options:

- White, Red, Blue, Green and Yellow
- Customize the jumping platform with your logo. The logo can only be applied to the white Sandback model.

	Code	Standard PACKAGING	Standard weight kg	Standard Volume m ³	Unit Price Euro
Velocity Advantage, TrueTread™	VELO-ADV-BK-T	1	53	-	9,000.00
Velocity Advantage non-slip anchor	VELO-ADV-BK-S	1	53	-	9,700.00
kit	27-111	1	53	-	600.00

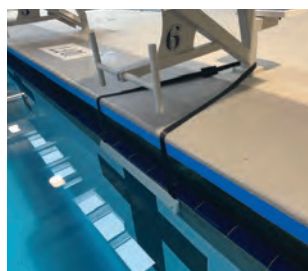

BACKSTROKE SWIMMING E 1T1M_{system}



- Raised, diamond-patterned non-slip backing.
- Two 5-foot polyester straps with stainless steel cam buckles for fixing and adjusting the height.
- Compatible with all jumping platforms.

	Code	Standard PACKAGING	Standard weight kg	Standard Volume m ³	Unit Price Euro
Backstroke start training system	03-650T	1	1.4	-	650.00

OLIMPIC POOL DIVING PLATFORMS



BACKSTROKE SWIMMING START SYSTEM 1



Designed to help make backstroke starts faster and reduce the chance of slipping, the Backstroke Start System offers the option of easily adding this feature to any pool platform or diving platform configuration.

- Raised, diamond-patterned non-slip backing.
- The height of the protruding section can be easily adjusted with one hand, both inside and outside the pool.
- The end of the reel is marked with millimeter increments (-40, -20, 0, 20, 40).
- Durable HDPE frame to protect against harsh elements indoors and outdoors.
- Three unique mounting options for securing the device to most platform and podium configurations.
- Clear markings on the reel to indicate the height of the protrusion above the water level for compatibility.
- Complies with FINA 2.10 standard.

3 mounting options:



ANCHOR MOUNTING KIT

Anchoring the plastic ba_11 to the ground with stainless steel butterfly screws.



BRACKET MOUNTING KIT

10-foot long polyester strap and stainless steel cam buckle with vinyl-coated 1/4" thick stainless steel bracket.



SQUARE PODIUM ANCHOR KIT

Vinyl-coated 1/4" thick stainless steel sheet and two brackets shaped to lock into 2-inch square single-post frames.

	Code	Standard PACKAGING	Standard weight kg	Standard Volume m ³	Unit Price Euro
Backstroke start system,	BSS1000	1	11	-	1,600.00
Anchor mounting kit.	13-600	1	2.3	-	320.00
Bracket mounting kit	13-601	1	3.2	-	320.00
Square podium anchor kit	13-603	1	4.6	-	850.00



PODIUMS 1Q1N ELEVATION PLATFORMS

AstralPool has expanded its Olympic product range by manufacturing a lifting platform for diving platforms. This part is made of AISI-304 stainless steel and plastic grid. The platform can also be used as a turning panel and includes anchors for the lanes.



EN 13451-1
EN 13451-1-6
Compliant with standards

	Code	Standard PACKAGING	Standard weight kg	Standard Volume m ³	Unit Price Euro
2 m wide lifting platform, 2.5 m wide	34213	1	-	-	5,600.00
lifting platform, lifting platform right	34214	1	-	-	5,650.00
corner.	34215	1	-	-	2,850.00
Upgrade platform left corner	34216	1	-	-	2,600.00

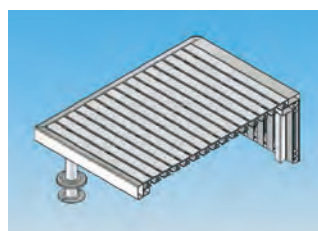

34216

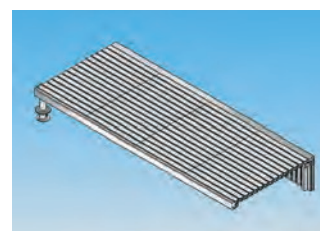

34213 - 2 m
34214 - 2.5 m

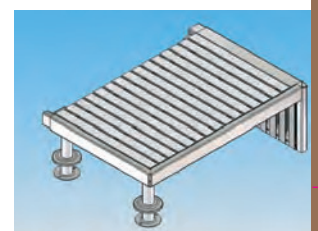

34215

STAGE ANCHORS

Anchors made of stainless steel AISI-304 or AISI-316 for fixing the podiums into the concrete. Includes bolts, washers, and grounding connection.

	Code	Standard PACKAGING	Standard weight kg	Standard Volume m ³	Unit Price Euro
AISI-316					
Jump podium anchor1	54460	1	2.4	0.02	280.00
Podium anchor1	54461	1	3.5	0.02	155.00
AISI-304					
Podium anchor1	54462	1	2.4	0.02	150.00

Anchor code 54460 is compatible with podiums coded 28760, 28761, and 53875.

Anchor code 54461 is compatible with podiums coded 00144, 00145, and 19956.

Anchor code 54462 is compatible with podiums coded 27578.

LANE SEPARATORS¹

JUMPING PODIUM NUMBERS

Each number comes in a pack of four.



Height
80 mm

Height
100 mm

	Code	Standard PACKAGING	Standard weight kg	Standard Volume m ³	Unit Price Euro
Height 80mm, for jump platforms with codes 00146 - 27578 - 278361					
Set of 1-6 Set of 1-10	28616	1	-	-	120.00
	28617	1	-	-	180.00
Height 100mm, for jump platforms with codes 00144 - 00145 - 19956 - 28760 - 28761 - 538751					
Set of 1-6 Set of 1-10	34200	1	-	-	420.00
	34201	1	-	-	680.00



BCN03 model separator

The separator parts are prepared with a 6 mm stainless steel cable (code 28808), a spiral separator tensioner (00208), and a spring-loaded separator hook (code 01468). A wave breaker is present inside the body. The outer diameter is 148 mm and it complies with the rules of the International Swimming Federation (FINA).

	Code	Standard PACKAGING	Standard weight kg	Standard Volume m ³	Unit Price Euro
25 m					
Red - White	67599	1	-	-	3,800.00
Red - Green	67601	1	-	-	3,800.00
Red - Blue	67602	1	-	-	3,800.00
Red - Yellow	67603	1	-	-	3,800.00
50 m					
Red - White	67600	1	-	-	7,600.00
Red - Green	67604	1	-	-	7,600.00
Red - Blue	67605	1	-	-	7,600.00
Red - Yellow	67606	1	-	-	7,600.00

1. Desired size, color combination and rope It is available.



FINA Standards
suitable

LANE SEPARATORS¹
SYDNEY_{model}

With a diameter of Ø148 mm, it complies with the rules of the International Swimming Federation (FINA) and the requirements for the Olympic Games and World Championships. The separator parts are supplied with a 6 mm stainless steel cable (code 28808), a spiral separator tensioner (00208), and a spring-loaded separator hook (code 01468).

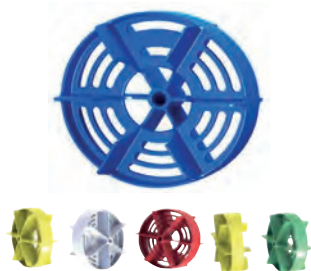

1. Desired size, color combination and rope It is available.



	Code	Standard PACKAGING	Standard weight kg	Standard Volume m ³	Unit Price Euro
12.5 m*					
White	67607	1	-	-	1,300.00
16.5 m					
White	67608	1	-	-	1,580.00
25 m					
Red - White	67609	1	-	-	2,200.00
Red - Green	67612	1	-	-	2,200.00
Red - Blue	67613	1	-	-	2,200.00
Red - Yellow	67614	1	-	-	2,200.00
33 m					
Red - White	67610	1	-	-	3,050.00
50 m					
Red - White	67611	1	-	-	4,400.00
Red - Green	67615	1	-	-	4,400.00
Red - Blue	67616	1	-	-	4,400.00
Red - Yellow	67617	1	-	-	4,400.00

* Available in other colors (blue, green, yellow)

ROMAN MODEL

The separator parts are shipped with a 7 mm stainless steel cable (code 00210), a screw-type separator tensioner (00209), and a flat separator hook (code 00207).

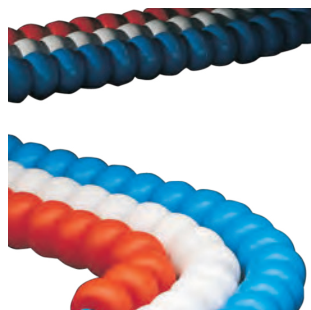

	Code	Standard PACKAGING	Standard weight kg	Standard Volume m ³	Unit Price Euro
12.5 m White	67618	1	-	-	430.00
16.5 m White	67619	1	-	-	510.00
25 m Orange - White	67620	1	-	-	640.00
33 m Orange - White	67621	1	-	-	850.00
50 m Orange - White	67622	1	-	-	1,175.00

* Available in other colors (blue, green, red)

MOSCOW MODEL

The separator is mounted on a 7 mm special polyester rope (code 00210) and is supplied with a screw-type separator tensioner (00209) and a flat separator hook (code 00207).



	Code	Standard PACKAGING	Standard weight kg	Standard Volume m ³	Unit Price Euro
12.5 m White	67623	1	-	-	635.00
16.5 m White	67624	1	-	-	760.00
25 m Orange - White	67625	1	-	-	1,100.00
33 m Orange - White	67626	1	-	-	1,500.00
50 m Orange - White	67627	1	-	-	2,175.00

* Available in other colors (blue, green, red)

LANE SEPARATORS1 STORAGE EQUIPMENT

BCN03 Lane separator collection trolley



The BCN03 is a cart designed for transporting and storing separators. It is made of AISI-316 stainless steel. It has a PVC bag for collecting excess water, which is emptied in a controlled manner without splashing from the bottom. For maximum mobility, the cart has 4 wheels, two of which are fitted with brakes. It stores 1 separator up to 50 m in length and is compatible with all separator models.

Code	Standard PACKAGING	Standard weight kg	Standard Volume m ³	Unit Price Euro
28623	1	55.00	0.389	4,450.00
28623	1	55.0	0.389	

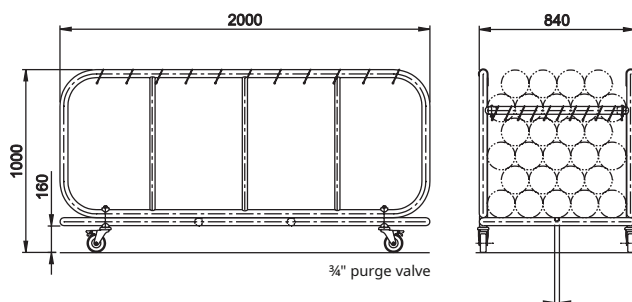

LANE SEPARATOR WRAPPING CART

The separator trolley, made of AISI-304 grade stainless steel, has four wheels, two of which have brake support for easy transport.

	Code	Standard PACKAGING	Standard weight kg	Standard Volume m ³	Unit Price Euro
1.2 m width	58860	1	27	0.31	2,255.00
1.8 m width	58869	1	32	0.45	2,900.00

SEPARATOR TRANSPORT NUMBERS						
Model	1.2 m			1.8 m		
	25 m	33 m	50 m	25 m	33 m	50 m
ROME	8	6	4	12	9	6
SYDNEY	2	1	1	3	2	1
MOSCOW	4	2	2	6	3	3

TECHNICAL SPECIFICATIONS						
Code	A	B	C	D	TO	F
58860	1415	1125	1165	690	970	1085
58859	2015	1725				

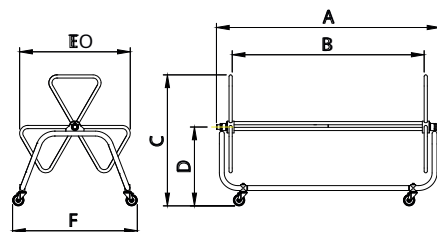

LANE SEPARATORS¹ ACCESSORIES

UNDER THE PLATFORM¹separator collection system

Made of AISI-316 grade stainless steel. Enables the collection of lanes under the walking platform. This unit can be complemented with a lane separator storage trolley if required.



Code	Standard PACKAGING	Standard weight kg	Standard Volume m ³	Unit Price Euro
15842	1	12.8	0.08	1,950.00

15842 1 12.8 0.08

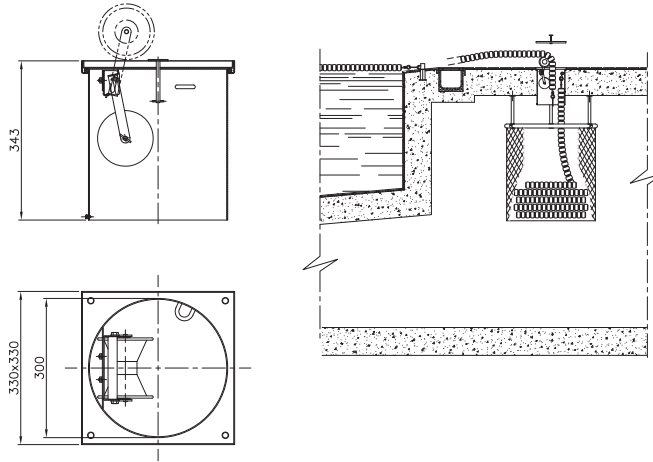

Zurich/Wiesbaden type assembly diagram¹

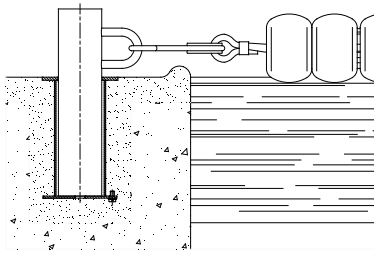

Anchor Ask1 hook1

Code 00141
Code 00140

Fin type assembly diagram¹

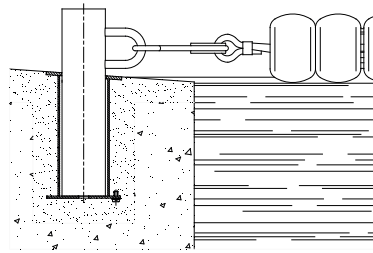

Anchor Ask1 hook1

Code 00142
Code 00140

Standard type assembly diagram¹

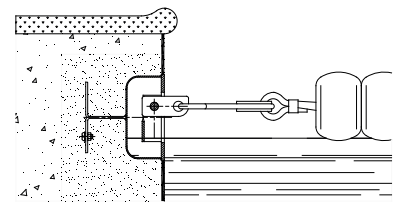

Anchor

Code 09206
Code 09207
Code 00205
Code 00206



HANGER HOOK

Made from AISI-316 stainless steel. Used with 00141 and 00142.

Code	Standard PACKAGING	Standard weight kg	Standard Volume m ³	Unit Price Euro
00140	2	0.63	0.003	80.00



WALL TYPE ANCHOR

It is manufactured from AISI-316 stainless steel.

Code	Standard PACKAGING	Standard weight kg	Standard Volume m ³	Unit Price Euro
09206	1	0.4	0.001	90.00

For reinforced concrete pools

LANE SEPARATORS1 ACCESSORIES

WALL-MOUNTED ANCHOR

It is manufactured from AISI-316 stainless steel.

	Code	Standard PACKAGING	Standard weight kg	Standard Volume m ³	Unit Price Euro
Anchors with movable hooks for reinforced concrete pools.	00205	1	0.46	0.001	115.00

SPIRAL SEPARATOR TENSIONER

Chrome-plated brass tensioner.

	Code	Standard PACKAGING	Standard weight kg	Standard Volume m ³	Unit Price Euro
	00208	1	0.97	0.002	205.00

V1DALI SEPARATOR TENSIONER

It is manufactured from AISI-316 stainless steel.

	Code	Standard PACKAGING	Standard weight kg	Standard Volume m ³	Unit Price Euro
	00209	1	0.2	0.001	80.00

SPRING SEPARATOR TENSIONER

It is manufactured from AISI-304 stainless steel.

	Code	Standard PACKAGING	Standard weight kg	Standard Volume m ³	Unit Price Euro
	01468	1	0.62	0.002	140.00

SEPARATOR 1C1N STRAIGHT HOOK

It is manufactured from AISI-304 stainless steel.

	Code	Standard PACKAGING	Standard weight kg	Standard Volume m ³	Unit Price Euro
	00207	10	5	0.01	25.00

1GOOSE SETS1

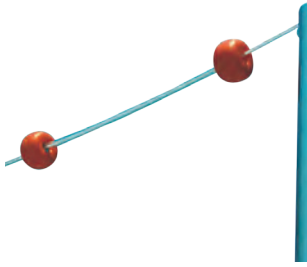

FAULTY EXIT_ 1 GOOSE SET1

Please specify the pool width when placing your order.

It consists of two 1.8m high stainless steel masts (AISI-316 grade). It is supported by warning balls. Anchors 00141, 00142, 19960, 19961 are not included with the yachts. It can be easily assembled.

NOTE:
You must state the pool dimensions and depths on placing your order.



FINA Standards
suitable



NOTE:
You must state the pool dimensions and depths on placing your order.



FINA Standards
suitable

Code	Standard PACKAGING	Standard weight kg	Standard Volume m ³	Unit Price Euro	
Error1 exit1_ warning set					
- Set consisting of 2 pieces of Ø43 mm pipe for a pool width of 21 m (to be used with 00141 or 00142).	19950	1	5.6	0.01	575.00
- For a pool width of 25 m					
Set consisting of 2 x Ø48 mm pipes (for use with 19960 and 19962).	19515	1	9.4	0.01	675.00
Error1 exit1_ warning balls1					
Polyester rope and balls 12.5 m	19954L125	1	-	-	255.00
Polyester rope and balls 21.0 m	19954L210	1	-	-	440.00
Polyester rope and balls 25.0 m	19954L250	1	-	-	500.00

GER1 RETURN_ 1 GOOSE SETS1

Please specify the pool width when placing your order.

It is manufactured from four (AISI-316 grade) stainless steel pipes, each 1.8 m high. Anchors 00141, 00142, 19960, 19961 are not included in the price. It is easy to assemble.

Code	Standard PACKAGING	Standard weight kg	Standard Volume m ³	Unit Price Euro	
Return warning set					
- Set consisting of 2 pieces of Ø43 mm pipe for a pool width of 21 m (to be used with 00141 or 00142).	19952	1	11.2	0.03	800.00
- For a pool width of 25 m					
Set consisting of 2 x Ø48 mm pipes (for use with 19960 and 19962).	19953	1	20.0	0.03	925.00
Return_ warning flags1					
2 sets of polyester rope and flags 12.5 m 2	19955L125	1	-	-	485.00
sets of polyester rope and flags 21.0 m 2	19955L210	1	-	-	785.00
sets of polyester rope and flags 25.0 m	19955L250	1	-	-	890.00

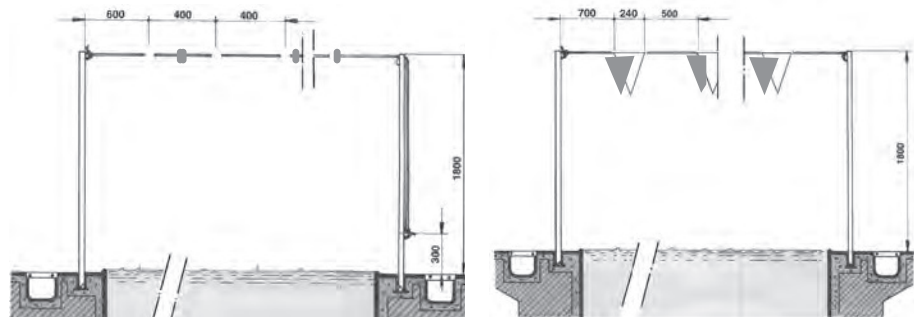

ROTATING PANELS1

ROTATING PANELS1

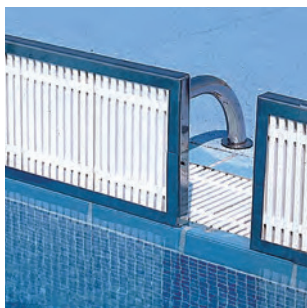

ROTATING PANELS1

300 mm high panel made of AISI - 316 stainless steel. Panel support (00139) is not included.

	Code	Standard PACKAGING	Standard weight kg	Standard Volume m ³	Unit Price Euro
Lane width 2 m	00137	1	13.6	0.040	1,300.00
Lane width 2.5 m	00138	1	16.5	0.051	1,400.00

ROTATING PANEL BRACKET1

AISI-316 stainless steel panel support piece for use with anchors 00141 and 00142. (00141 and 00142)

(Bed not included) When ordering, please specify H and L dimensions and the type of ducting. A minimum of two units is required for each rotary panel.

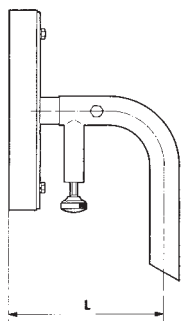

EN 13451-1
EN 13451-1-6
Compliant with standards

	Code	Standard PACKAGING	Standard weight kg	Standard Volume m ³	Unit Price Euro
Lane width 2 m	00139	1	4.0	0.054	LFS

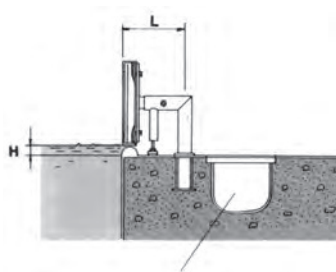

BRACKET SYSTEM1

LENGTH «L» LESS THAN 500 MM 1SE.

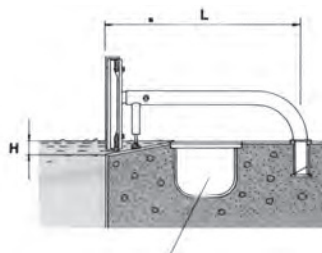
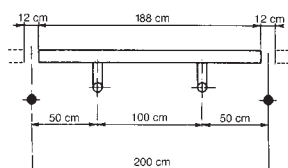
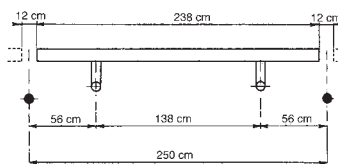

BRACKET SYSTEM1

"L" LENGTH MORE THAN 500 MM.

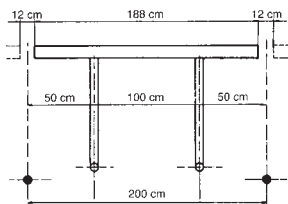
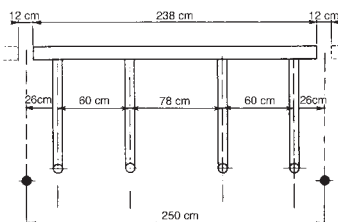

ANCHORS



STRAIGHT anchor

It is manufactured from AISI-316 for the Zurich-Wiesbaden system..

	Code	Standard PACKAGING	Standard weight kg	Standard Volume m ³	Unit Price Euro
For Ø 43 mm pipe.	00141	2	1.17	0.002	155.00
For Ø 48 mm pipe.	19960	2	1.30	0.002	165.00



E 1K anchor

It is manufactured from AISI-316 for the Finnish system.

	Code	Standard PACKAGING	Standard weight kg	Standard Volume m ³	Unit Price Euro
For Ø 43 mm pipe.	00142	2	1.13	0.002	155.00
For Ø 48 mm pipe.	19961	2	1.26	0.002	185.00



TESP1T C1VATALI anchor

Made from AISI-316 steel. Bolted type..

	Code	Standard PACKAGING	Standard weight kg	Standard Volume m ³	Unit Price Euro
	00143	2	1.47	0.003	225.00

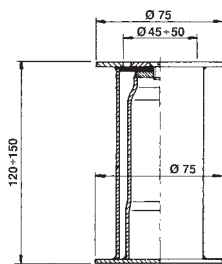

Code 00141
Code 19960

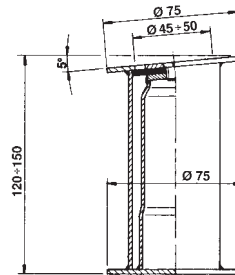

Code 00142
Code 19961

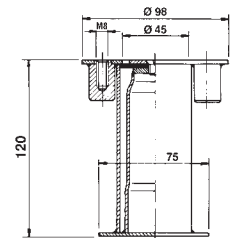

Code 00143

WATER POLO CASTLE 1



WATER POLO CASTLE 1

The water polo goal is lightweight, buoyant, and very durable. It is made of aluminum and is white in color. It is manufactured according to FINA (International Swimming Federation) standards.

- Castle frame: Made of 80 x 50mm aluminum.
- Network connection: 6 mm stainless steel rod.
- Mesh tube: Float frame made of 23 mm stainless steel tube.
- Fixing for goal lines. Nets included.



	Code	Standard PACKAGING	Standard weight kg	Standard Volume m ³	Unit Price Euro
Water polo goal kit	69654	1	-	-	12,500.00

HOEING locking socket



C1vatal1. Made of AISI-316 stainless steel.

Code	Standard PACKAGING	Standard weight m3 in kg	Standard volume
00143	1	1.47	0.003

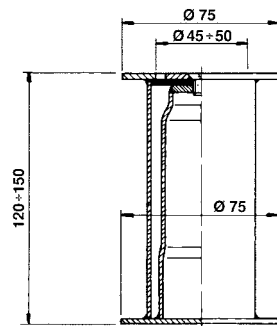

Code 00141
Code 19960

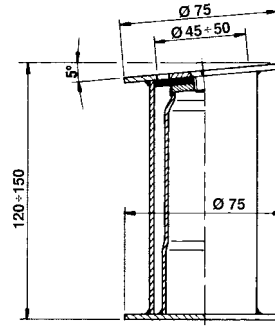

Code 00142
Code 19961

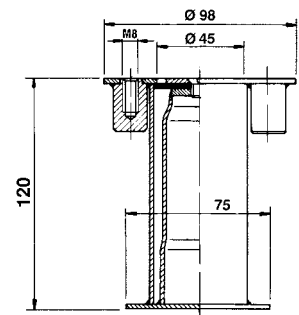

Code 00143

WATER POLO EQUIPMENT

WATER POLO COMPETITION FIELD - MOSCOWSTRIP ROPES



REAR transverse MOSCOW

Red penalty area included, white/white. Hook and tensioning device included.

	Code	Standard PACKAGING	Standard weight in kg	UNIT PRICE EURO
Pool dimensions: 50 x 25 m. Moscow 11 m lanes ø 100 mm	77450	4	40	♦♦♦♦♦♦
Pool dimensions: 33 x 25 m. Moscow 11 m lanes ø 100 mm	77458	4	40	♦♦♦♦♦♦
Pool dimensions: 25x16 m. Moscow style, 7 m lanes. ø 100 mm	77466	4	30	♦♦♦♦♦♦



FRONT TRANSVERSE MOSCOW

Red penalty area, including white/red color. HookThe filling device 1 is included.

	Code	Standard PACKAGING	Standard weight in kg	UNIT PRICE EURO
Pool dimensions: 50 x 25 m. Moscow 11 m lanes ø 100 mm	77451	4	40	♦♦♦♦♦♦
Pool dimensions: 33 x 25 m. Moscow 11 m lanes ø 100 mm	77459	4	40	♦♦♦♦♦♦
Pool dimensions: 25x16 m. Moscow style, 7 m lanes. ø 100 mm	77467	4	30	♦♦♦♦♦♦



MOSCOW NEXT TO THE END

Longitudinal Moscow track for women and men. Includes special spring and tensioning mechanism.

	Code	Standard PACKAGING	Standard weight in kg	UNIT PRICE EURO
Pool dimensions: 50 x 25 m. Moscow 50 m lanes ø 100 mm	77452	2	100	♦♦♦♦♦♦♦♦
Pool dimensions: 33 x 25 m. Moscow 33 m lanes ø 100 mm	77460	2	65	♦♦♦♦♦♦♦♦
Pool dimensions: 25x16 m. Moscow 25 m lanes ø 100 mm.	77468	2	45	♦♦♦♦♦♦♦♦

WATER POLO EQUIPMENT

WATER POLO TRAINING GROUND - ROMA LANE 1PLR1



REAR END ROMA

ASTRALPOOL

Red penalty area including white/white. Hook and mounting bracket 1 is included.

	Code	Standard PACKAGING	Standard A 1r1k in kg	UNIT PRICE EURO
Pool dimensions: 50 x 25 m. Roma 11 m lanes, \varnothing 80 mm.	77454	4	34	*****
Pool dimensions: 33 x 25 m. Roma 11 m lanes. \varnothing 80 mm.	77462	4	34	*****
Pool dimensions: 25x16 m. Roma 7 m lanes \varnothing 80 mm.	77470	4	24	*****



PRE-TRANSVERSAL ROME

ASTRALPOOL

Red penalty area included, white/red color. Hook and tensioning device included.

	Code	Standard PACKAGING	Standard weight in kg	UNIT PRICE EURO
Pool dimensions: 50 x 25 m. Roma 11 m lanes. \varnothing 80 mm.	77455	4	34	*****
Pool dimensions: 33 x 25 m. Roma 11 m lanes. \varnothing 80 mm.	77463	4	34	*****
Pool dimensions: 25x16 m. Roma 7 m lanes \varnothing 80 mm.	77471	4	24	*****



ROMAN NEXT

ASTRALPOOL

Longitudinal Roman belt for women and men. Includes special spring and tensioning mechanism.

	Code	Standard PACKAGING	Standard weight in kg	UNIT PRICE EURO
Pool Dimensions: 50 x 25 m. Roma 50 m lanes \varnothing 80 mm	77456	2	80	*****
Pool dimensions: 33 x 25 m. Roma 33 m lanes \varnothing 80 mm	77464	2	50	*****
Pool dimensions: 25x16 m. Roma 25 m lanes \varnothing 80 mm	77472	2	40	*****





World Water Sports1

WATER POLO CASTLES



Two official water polo goal sets (a) conforming to World Aquatics Federation standards.

(including the sides). 1st dimension: 300 x 9 cm.

	Code Standard	PACKAGING	Standard weight in kg	UNIT PRICE EURO
2 water polo goal sets	69654P	1	120	*****

WATER POLO CASTLE TRAINING



1 set of two water polo goalposts (including A-line).

	Code	Standard PACKAGING	Standard weight in kg	UNIT PRICE EURO
Set of 2 Water Polo Goals (180 x 90 x 100 cm)	77474	1	30	*****
Set of 2 Water Polo Goals (250 x 90 x 100 cm)	77475	1	40	*****



SPRING COVER PROTECTION



	Code	Standard PACKAGING	Standard A in kg	1rl1k	UNIT PRICE EURO
Spring Cap 1 Protector (12 cm x 10 cm diameter)	76552	1	0.3		*****

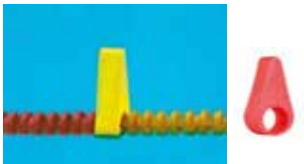

18'L1 FOAM CONE SET1 For WP Area 1



	Code	Standard PACKAGING	Standard A in kg	1rl1k	UNIT PRICE EURO
2 white, 4 yellow, 12 red.					
Set of 18 foam cones	76553	1	4		*****



WATER POLO MATCH STARTING BALL



	Code	Standard PACKAGING	Standard A in kg	1rl1k	UNIT PRICE EURO
A 25-meter rope is included.					
Central Competition Service	71445	1	3		*****

WATER POLO EQUIPMENT

WATER POLO ACCESSORIES



EYE PIERCING 1 1



	Code	Standard PACKAGING	Standard weight in kg	UNIT PRICE EURO
Eyelash	75882	2	3	*****



WATER POLO FLAG SET 1



8 pieces (2 red, 2 green, 2 white, 2 yellow).	Code	Standard PACKAGING	Standard A in kg	1r1k	UNIT PRICE EURO
Water polo flags1 team1	75883	8	3		*****



NON-SLIP FLOOR REFEREE PLATFORM



	Code	Standard PACKAGING	Standard weight in kg	UNIT PRICE EURO
Non-slip surface (10 meters x 100 cm width)	77476	1	40	*****



REFEREES ON THE PODIUM AND STORAGE CART



Referee platform with removable legs for easy storage.

Storage cart for the referee platform.

Three storage carts are required for the two referee platforms.

	Code	Standard PACKAGING	Standard A in kg	1r1k	UNIT PRICE EURO
Referee platform 34 meters. Storage	77477	2	-		*****LFS
cart for referee platform.	77478	3	-		LFS



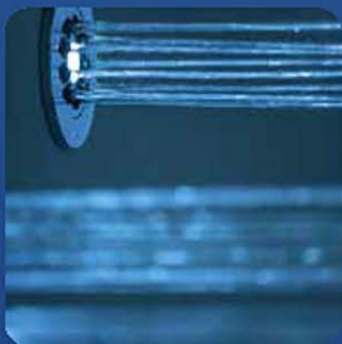
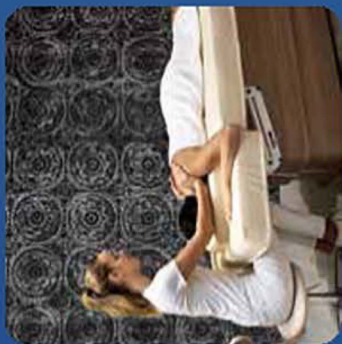



ICE GENERATOR K1T

+ AstralPool's ice-making kit is a robust and efficient set of equipment, containing everything you need to quickly set up and get the equipment up and running, from the ice crusher to the stainless steel dispenser.

"Two different versions are available: Ceiling type with installation via 1t1c1 and wall type with installation via 1t1c1 setup.

"Ice making machine options with water or air-cooled condensers are available.

Ice making kit (water so (utmal1 ice machine with condenser)	UNIT PRICE EURO	Code
Stainless steel roof type	LFS	73892
1t1c1 Matte black ceiling type	*****	73894
in 1t1c1 Stainless steel wall	*****	73893
type of 1t1c1 Matte black wall type	*****	73895
da 1t1c1		
Ice making kit (air so (utmal1 ice machine with condenser)	UNIT PRICE EURO	Code
Stainless steel roof type	*****	73892A
1t1c1 Matte black ceiling type	*****	73894A
in 1t1c1 Stainless steel wall	*****	73893A
type of 1t1c1 Matte black wall type	*****	73895A
da 1t1c1		

ICE MAKING MACHINE

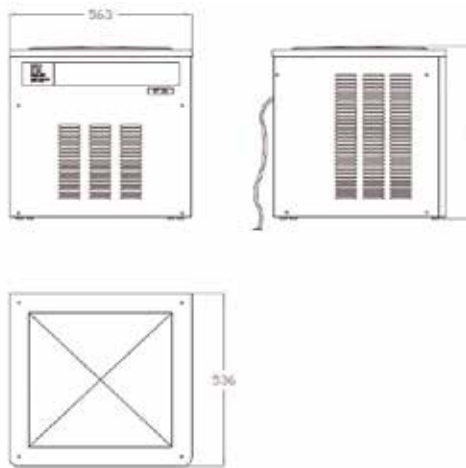

ICE DROP TUB

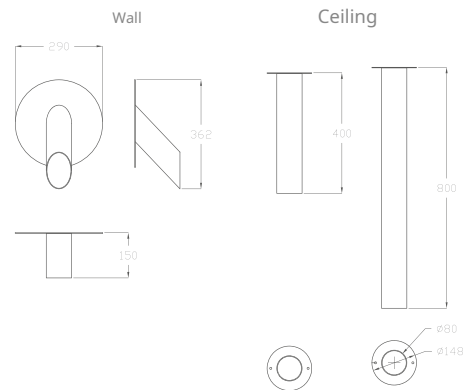

K1T 1ÇER1 1 - WALL

" An ice machine with a capacity to produce 200 kg of ice in 24 hours.

" Support brackets for ice making machines.

" Wall-mounted ice packs made of 316 stainless steel, available in bright or matte black.

" Wall-mounted photocell (Ice level control equipment1).

" Freezer included.

K1T 1ÇER1 1 - CEILING

" An ice machine with a capacity to produce 200 kg of ice in 24 hours.

" Support brackets for ice making machines.

" Made of 316 stainless steel, with a glossy or matte black finish, this ceiling-mounted ice cooler is also available.

" Photocell (Ice level control equipment). Placement ba l1 is located on the wall or inside the tube.

" Freezer included.



Asana



Sutra



Stud farm



Brandha



Cala



Ice cube 1



Ice cube 2

ICE CRESCENT1

ICECONTAINER

- + With its clean and elegant lines, the AstralPool ice hopper is a perfect complement to the Ice Generator Kit.
- + Designed in harmony with the steam baths¹ and ice cabin series¹, it creates clean and homogeneous spaces.

Porcelain Ice Cube Tray

"Large porcelain cup. The base ring is made of anodized aluminum. 20-liter capacity.

"ASANA: Fokos Grafite large format slate covered with black porcelain.

"BANDHA: Large format sand porcelain coated with Fokos Sale.

"CALA: Large grey porcelain covered with Calce Tortora.

"HARA: Coated with wide-format porcelain oxide perla.

"SUTRA: Large format porcelain Statuarietto kaplanm1_t1r.

	UNIT PRICE	Code
	EURO	
Porcelain Ice Cube Tray		
Asana	♦♦♦♦♦♦♦♦	73896
Sutra	♦♦♦♦♦♦♦♦	73898
Bandha	♦♦♦♦♦♦♦♦	73899

Customizable coatings for steam and ice chambers. Customization options are available for any of the following.

Porcelain Ice Tray

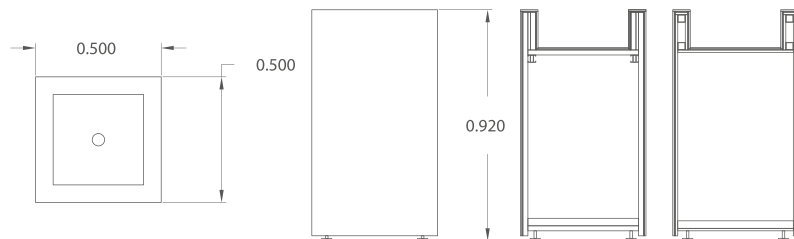

	Code
This surface of the container	
Ice cube 1	77164
Ice cube 2	on demand

SOLID SURFACE ICE TRAY

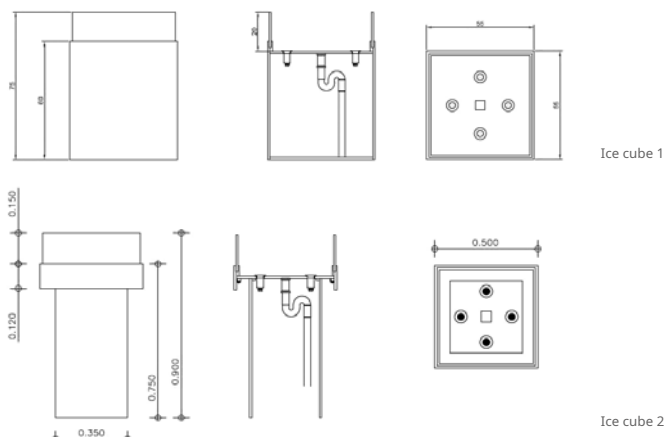

ICE CRESCENT1



SNOWPRO

- + Feel the gentle caress of Snowpro on your skin.
- + It produces the highest quality natural snow and features advanced technology for use in ambient temperatures up to 45 degrees Celsius.
- + Combine Snowpro with a room specifically designed for your project.
- + Enhance your inner peace and allow relaxation to envelop you. The subtle contrast between warmth and texture transports you to a different world, a comfortable yet motivating place.

Code

Snow Machine

Snow 1_1 05L	73945
Snow 1_1 08W	73946
Snow 1_1 016W	73947
Snow 1_1 25W	73948
Snow 1_1 32W	73949

TECHNICAL SPECIFICATIONS

Model	Snow Ya 1_1 05L	Snow Ya 1_1 08W	Snow Ya 1_1 16W	Snow Ya 1_1 25W	Snow Ya 1_1 32W
Code	73945	73946	73947	73948	73949

GENERAL

Dimension	650 x 650 x 437 mm	910 x 830 x 480 mm	910 x 830 x 480 mm	910 x 830 x 900 mm	2 x 910 x 830 x 480mm 1 x 680 x 830mm
Size (capacitor)	650 x 650 x 468 mm				480 mm
A 1r1k	80 kg	90 kg	90 kg	125 kg	190 kg
So utma	Weather	This	This	This	This
Ba lant1	230 V	230 V	230 V	400 V	400 V
Strength	0.9 kW / 3.4 A	0.9 kW / 7.2 A	1.1 kW / 7.2 A	2.4 kW / 4.5 A	2.8 kW / 5.1 A

PROFIT

Quality	Do al	Do al	Do al	Do al	Do al
weight	approx_1k 140 kg/m3	approx_1k 140 kg/m3	approx_1k 140 kg/m3	approx_1k 140 kg/m3	approx_1k 140 kg/m3
Ak1_	approx_1k 0.7 m3/D	approx_1k 1.2 m3/ D	approx_1k 2.3 m3/ D	approx_1k 3.4 m3/ D	approx_1k 4.6 m3/D

HEAT

snow cover	max. +45°C	max. +45°C	max. +45°C	max. +45°C	max. +45°C
Installation area 1	max. +35°C	max. +35°C	max. +35°C	max. +35°C	max. +35°C

1STE E BA LI

Snow / LED Lighting	ü	ü	ü	ü	ü
Snow depth sensor	ü	ü	ü	ü	ü
Automatic on/off	ü	ü	ü	ü	ü

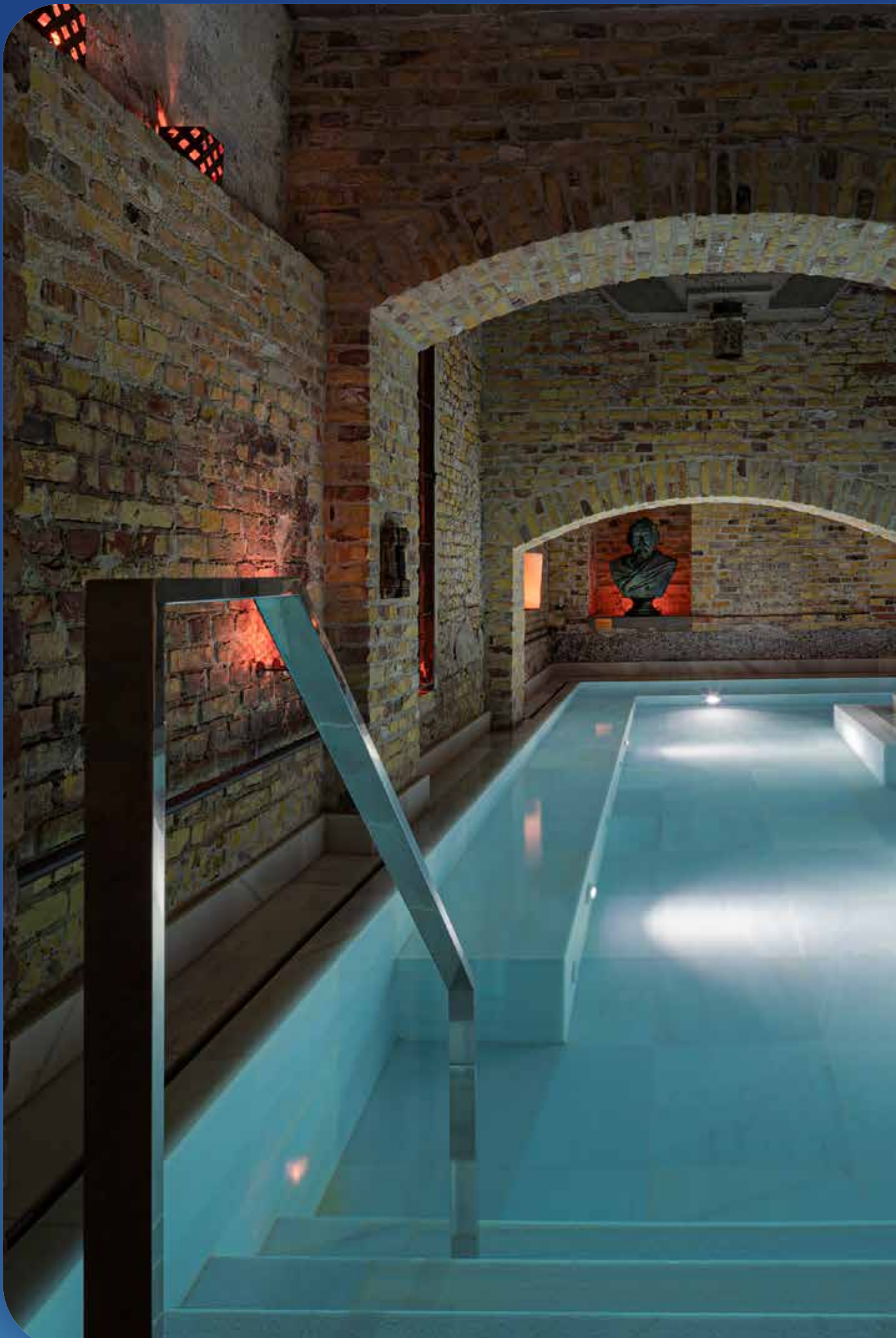











PRAYERS

EMOTIONAL DU_



Sensory showers and tunnels combine water, light, and temperature effects, all programmable. They are ideal for designs incorporating water and sensory atmospheres created using light, sound, and scents.

JET TYPES1



	<p>YA MUR</p> <p>The gentle jet of rainwater tickles the skin, providing a pleasant, stimulating and gentle sensation. A relaxing feeling.</p>		<p>NEBULIZED</p> <p>Vaporized air stream to the environment</p> <p>The snow envelops the body with a relaxing feeling. A renewed cloud of water.</p>		<p>TROP1KAL</p> <p>A continuous and powerful jet of water hits the body enveloping and revitalizing by massaging and replenishing energy</p> <p>It has an effect. energy.</p>
	<p>_ELALE</p> <p>The powerful movement of the waterfall draws us in and skin contact... It transmits its energizing effect through this pathway.</p> <p>Force applied to the entire body.</p>		<p>VENTILATED_</p> <p>Water and air mix and transform into each other.</p> <p>It strengthens, massages the body, and It has an effect.</p> <p>It fuels creativity and dynamism.</p>		<p>ATOMIZE ED1LM1_</p> <p>Water into tiny particles by reduction, atomized jet</p> <p>It provides a refreshing effect. and a relaxing feeling of well-being.</p>
	<p>TROPICAL VENTILATED_</p> <p>A mixture of tropical and atmospheric currents, a dense rain mur effect</p> <p>This creates a a 1 do relieve descending and Muscle tension It reduces it.</p>		<p>LED + NEBULIZER</p> <p>A blend of different therapies and effects, LED light optimizes regenerative effects and Enriches. Nebulization.</p>		<p>LED + ATOMIZE</p> <p>Water particles and LED 1_1 1n1n</p> <p>The combination of 1s1s1n1n enhances and intensifies the effect. The delicate touch of the atomized jet.</p>
	<p>LAMA</p> <p>Having a 180-degree axial mist jet.</p> <p>Targeting a specific area of the body.</p>		<p>TURB1N</p> <p>Turbine-powered energy jet</p> <p>It has a strong and intense effect. to be.</p>		

ACCESSORIES

All accessories and optional features must be defined and requested when placing the order.

			
<p>Sound</p>	<p>Water aromatherapy</p> <p>Summaries: Mint/Tropical/Citrus/Eucalyptus</p>	<p>Air aromatherapy</p>	<p>The wrong way</p>

CONTROLS

		
<p>MANUAL</p> <p>Tu_tak1m1 arac111 Check each of the valves (on/off). (Many buttons as various jet types).</p>	<p>D1Z1</p> <p>Different1 Enable the pre-programmed sequence of hands. You can open the duffel caps with a single button press.</p>	<p>MULTIPLE D1Z1</p> <p>Depending on your needs, the program you want can be programmed. Activate sequence 1. Scheduled sequences: RELAXATION / BALANCE / SPORT / ENERGY1</p>

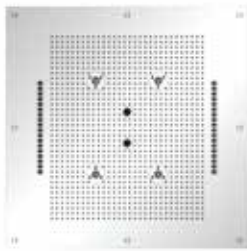

RGBW Lighting



SENSE PRO

"Square wall-mounted, 700x700 mm, for flush mounting.

"Complete kit including jets, 1_1klar, water temperature and control box for the installation system. 4 buttons, wall-mountable. It includes an IP67 stainless steel power supply and an electronically controlled 7-module flush-mount box (type 506) for managing 4 pre-configured programs (Relaxation, Energy, Balance, Sport). 12V load transformer.

"Materials: Ultra-gloss stainless steel plate, s1v1 silicone scale inhibitor membrane.

"Ceiling depth: 150 mm.

"Water boils at 1 1/2 inches.

	UNIT PRICE EURO	Code
Sense Pro	◆◆◆◆◆◆◆◆	AF-FL001-25

TECHNICAL SPECIFICATIONS

Code	Explanation	Lighting	Jets	Dimensions (cm)	Control	1st EBA I1
AF-FL001-25	SENSE PRO	RGBW		70 x 70	4 years ago <small>most</small> settings1_program m	

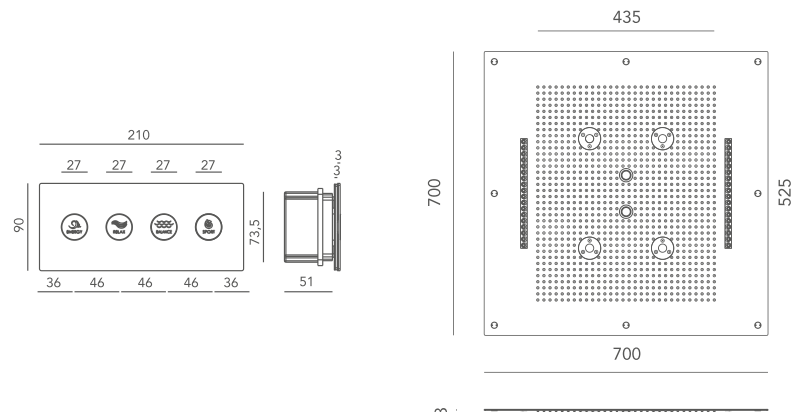

SENSUS RELAXATION PROGRAM

Relax Program 1 offers a comprehensive relaxation experience for both body and mind. It provides gentle, balanced water pressure and consistent temperatures to maintain balance. Chromotherapy uses soothing colors such as blue and indigo to enhance mental relaxation. Gentle piano music, soft rain sounds, and fresh aromas further stimulate the senses, creating a calm and peaceful atmosphere. This program offers a sanctuary for regaining balance and well-being.

SENSUS ENERGY1 PROGRAM

The "Energy" program is designed to revitalize and awaken muscles and skin using dynamic jets and varying temperatures. Ideal for the morning or after a spa day, this program reactivates the brain and stimulates the senses. Chromotherapy combines warm and cool colors for a dynamic visual effect. The program includes tribal sounds and a sensory rain dance for an engaging auditory experience, while citrus aromas such as lemon and orange enhance the feeling of vitality.

BALANCE PROGRAM SENSUS

The "Balance" program helps users regain their physical and mental balance through gentle and relaxing stimulation. It includes targeted water jet sequences that focus on areas such as the neck, shoulders, and back, reducing tension. A unique, metronome-like rhythm guides users to a relaxed state of concentration, balances their perception of time, and promotes harmonious mental stimulation.

SENSUS SPORTS PROGRAM

The "Sport" program 1 focuses on muscle recovery and relaxation after intense physical activity. It incorporates gradually changing water temperatures to stimulate circulation and aid muscle recovery. Sequential lateral jets massage various areas of the body to increase flexibility, reduce stiffness, and promote relaxation. Energizing sounds and aromas are also included in the program.

It revitalizes the body and mind, providing a feeling of vitality and renewal.

DU_LAR: WATER AREA

EMOTIONALDU_

AQUA SENSE

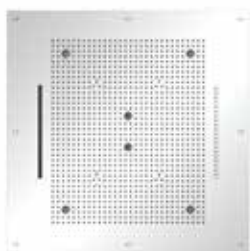

RGBW Lighting



- " Square-shaped, ceiling-mounted shower head, 1,700 x 700 mm. 4 different types of water Spray mode: 1 or rain jet,
- " 4 mist nozzles, 1 tropical spray nozzle, and 1 waterfall spray nozzle.
- " Includes 6 LED spotlights with chromotherapy features (1_1_1).
- " Super mirror 1 stainless steel plate, s1v1 silicone scale inhibitor membrane.
- " Ceiling depth: 150 mm.
- " Water boiling point 1: 1/2 inch
- " Operating pressure: 1.5 / 5 bar.
- " Recommended pressure: 3 bar.
- " Complete set including mounting system.

	UNIT PRICE EURO	Code
Aqua Sense Du_	♦♦♦♦♦♦♦♦	AF-FL002-25

TECHNICAL SPECIFICATIONS

Code	Explanation	Lighting	Jets	Dimensions (cm)	Control	1st EBA I1
AF-FL002-25	Sense of Water	RGBW		70 x 70	Sequence (1 du me)	

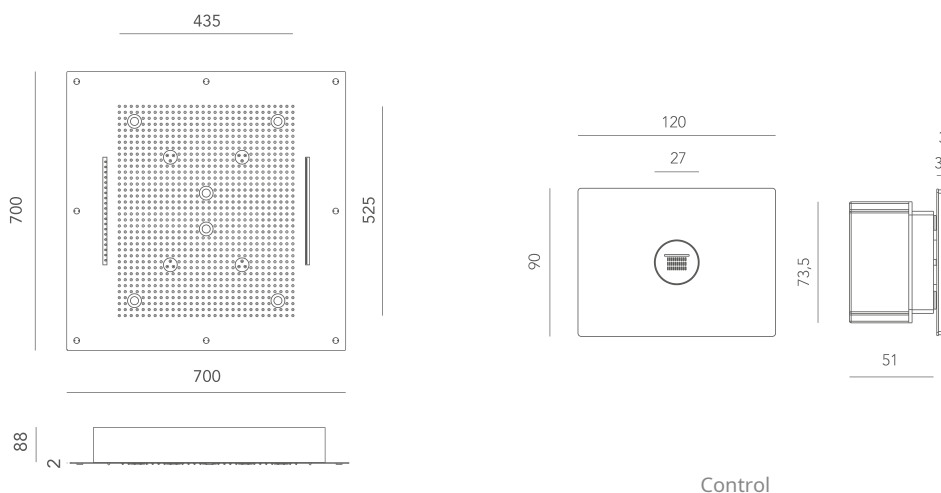

Control

SHOWERS

EMOTIONAL TUNNEL

AQUA TUNNEL 1

"Materials: Ultra-polished stainless steel plate, s1v1 silicone scale inhibitor membrane.

"Ceiling depth: 100 mm.

"Water boiling point 1: 1/2" (inches)

"Operating pressure: 1.5 / 5 bar.

"Recommended pressure: 3 bar.

Code

Water Tunnel

AF-FL033-25



TECHNICAL SPECIFICATIONS						
Code	Explanation	Lighting	Jets	Dimensions (cm)	Control	1ste e ba l1
AF-FL033-25	THIS	RGBW		35 x 35	1 du me (sequence)	

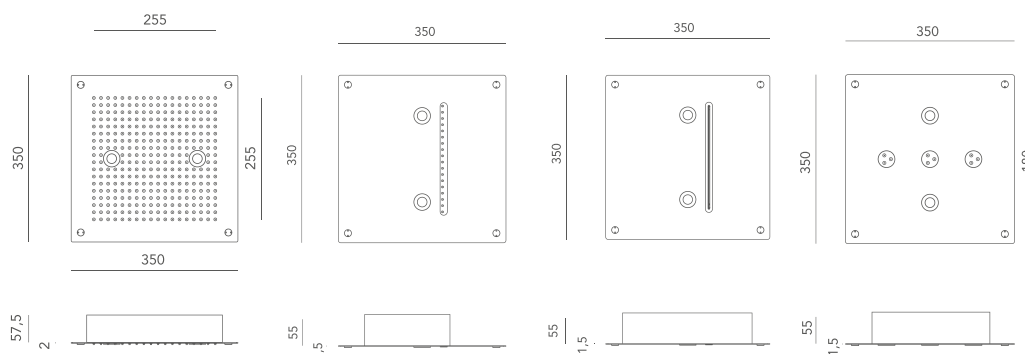

2 LED 1_1k11 1 rain spray head_l1 1 Chromotherapy is included.

Chromotherapy-featured 2 LED 1_1k11 1 tropical jet.

1 waterfall jet Chromotherapy Features 2 LEDs 1_1k.

Includes 3 atomizing jets. Chromotherapy Features 2 LEDs 1_1k.

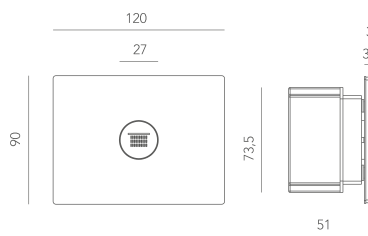

Activation with the button and sequential activation. (1ste e ba l1: reverse path)

SHOWERS

YA MUR

RAIN ROOM

Create your perfect RAIN ROOM: Experience the thrill of a tropical storm with rain, sounds and lights for an immersive and unforgettable spa experience.

The Rain Room is an innovative design within the spa, distinguished by its use of modular rain jets that can be placed throughout the room. This distinctive element adds a striking effect to the space and offers users a refreshing and enveloping experience.

RAIN ROOM's dynamic program is designed to create a sense of surprise and delight; a specific scenario activates numerous delicate water droplets, transforming the environment into a captivating world of simulated rain.

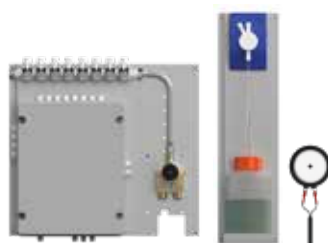
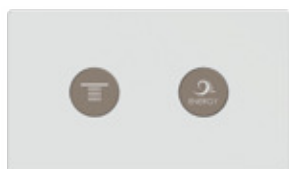
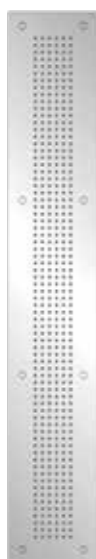

Code

Or mur 4	on demand
Or mur 6	on demand
	on demand

TECHNICAL SPECIFICATIONS

Model	YA MUR 4	YA MUR 6	YA MUR 8
Code	on demand	on demand	on demand
Du_type	Multisensory Rain Room1	Multisensory Rain Room1	Multisensory Rain Room1
Du_ba_l1 1 say1s1	4 integrated du_ba_l1 1 ceiling (1180x190 mm)	6 integrated du_ba_l1 1 ceiling (1180x190 mm)	8 pieces of wall-mounted connectors have been integrated. ceiling (1180x190 mm)
Jet/Spray type	Ya mur x4	Ya mur x6	Ya mur x8
Control	2 pieces of super mirror stainless steel tu_set steel buttons	2 super mirror sets stainless steel buttons	2 super mirror sets stainless steel buttons
Control unit	230 V 3 100 W Water supply ¾= M Pre-wired control panel, screen and manual thermostat	230 V 3 100 W Water supply ¾= M Pre-wired control panel, screen and manual thermostat	230 V 3 100 W Water supply ¾= M Pre-wired control panel, screen and manual thermostat
Work1_press1	1.5 3 5 bar (optimum 3 bar)	1.5 3 5 bar (optimum 3 bar)	1.5 3 5 bar (optimum 3 bar)
Recessed ceiling	150 mm	150 mm	150 mm
Options / Extras	Integrated pump aromatherapy (mint and citrus fruits) * Micro-featured sound system SD * 2 integrated converters	Aromatherapy (mint and citrus) * Recording audio from Micro SD card 1 * 4 integrated converters	Aromatherapy (mint and citrus) * Recording audio from Micro SD card 1 * 4 integrated converters
Dimensions technical unit	360 × 590 × 149.5 mm	360 × 590 × 149.5 mm	360 × 590 × 149.5 mm
Added value / Experience	Relaxing, do al 'fine rain' sensory experience	A wider scope 1 3 immersive experience	Full scope 1 '_waterfall' image and multisensory perception feature. dipping

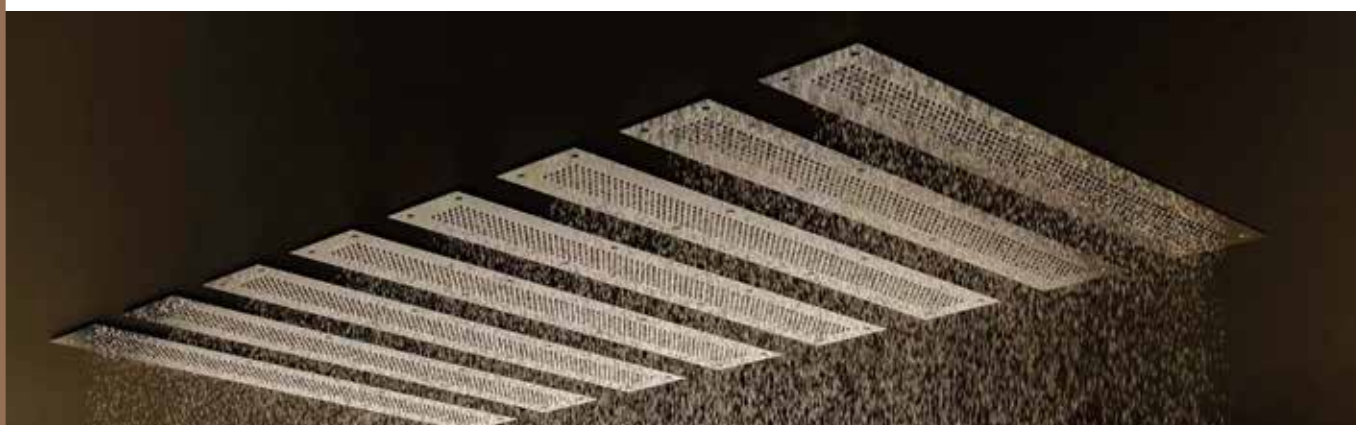

HOT AREA

CONTRAST SHOWER

"Made of chrome-plated brass, with sequential mist spraying and atomizer spraying capabilities, flush-mounted 3+3 nozzle. Bodyjet. Features RGBW LEDs for chromotherapy and temperature control.
 "1/2" water connection 1" 350mA consumption



	UNIT PRICE EURO	Code
Contrast Shower	♦♦♦♦♦♦♦♦	AF-FL038

TECHNICAL SPECIFICATIONS

Code	Explanation	Lighting	Jets	Dimensions (cm)	Control	1ste e ba l1
AF-FL038	Z1tt1k du_	RGBW		Ø 8.5	2 pushes buttons	

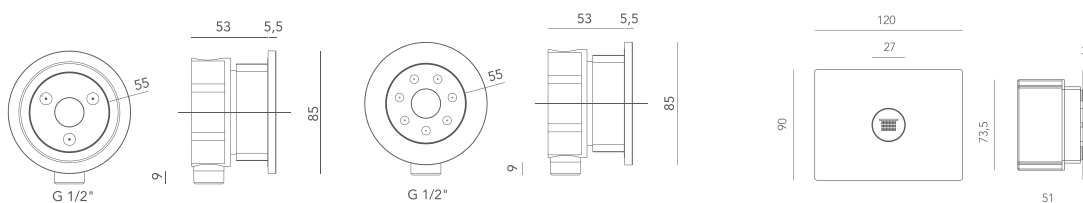

PRAVERS

SO UK REGION

AQUARIUS PRAYER

"A cube mounted on the wall or ceiling.
 "Capacity: 4.5 - 7.5 liters
 "Top diameter size: 305 mm
 "Height: 270 mm
 "Chain height: 630 mm
 "Turning radius: 480 mm
 "Pipe connection: 1/2"



Code

Bucket Cube Du_	87038
-----------------	-------

CONTRAST SHOWER

"Three Bodyjet jets with chrome-plated brass bodies, sequential control, and mist spraying capability. Suitable for chromotherapy and...
 Includes RGBW LEDs for temperature control.
 "1/2" water connection
 "350mA absorption



Code

Contrast Shower	AF-FL037
-----------------	----------

TECHNICAL SPECIFICATIONS

Code	Explanation	Lighting	Jets	Dimensions (cm)	Control	1ste e ba l1
AF-FL037	Z1tt1k du_	RGBW		Ø 8.5	1 push du me	

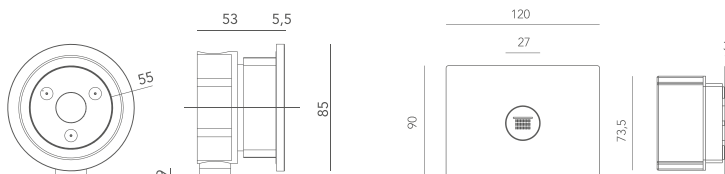

ZENIT

ZENITby aquaform

Manufactured by Aquaform, ZENIT is a horizontal shower and massage system made of super mirror-finished stainless steel, wall-mountable, with an electronic mixer, chrome-plated hand shower, chromotherapy features, and a touch control panel for managing or manually starting 4 preset programs (sport, energy, relaxation, balance).

Hydraulic features:

- "The water supply system operates with both hot and cold water.
- "Pressure 2/5 bar.
- "The recommended pressure is 3 bar.
- "For pressures higher than 5 bar, we recommend installing a pressure reducer.
- "So uk su s1 cakl1 1 100/ 150C
- "Hot water temperature 1 550/ 650C
- "Optimum hot water flow 15 l/min.

Notes:

- "Draining groundwater is essential for allowing water to flow freely.
- "If the water hardness is above 15/18 degrees Fahrenheit, a water softener should be installed.

Recommended. Electrical characteristics:

- "Electrical supply 100-240V 3 50/60Hz
- "12V transmission control panel.
- "Maximum absorption 100W
- "We recommend installing a separate RCCB (Residual Current Idle Circuit Breaker).
- "3 1_1kl1 RGB system.

Code

Zenit

AF-FL045

TECHNICAL SPECIFICATIONS

Code	Explanation	Lighting	Jets
AF-FL045	Zenit	RGBW	

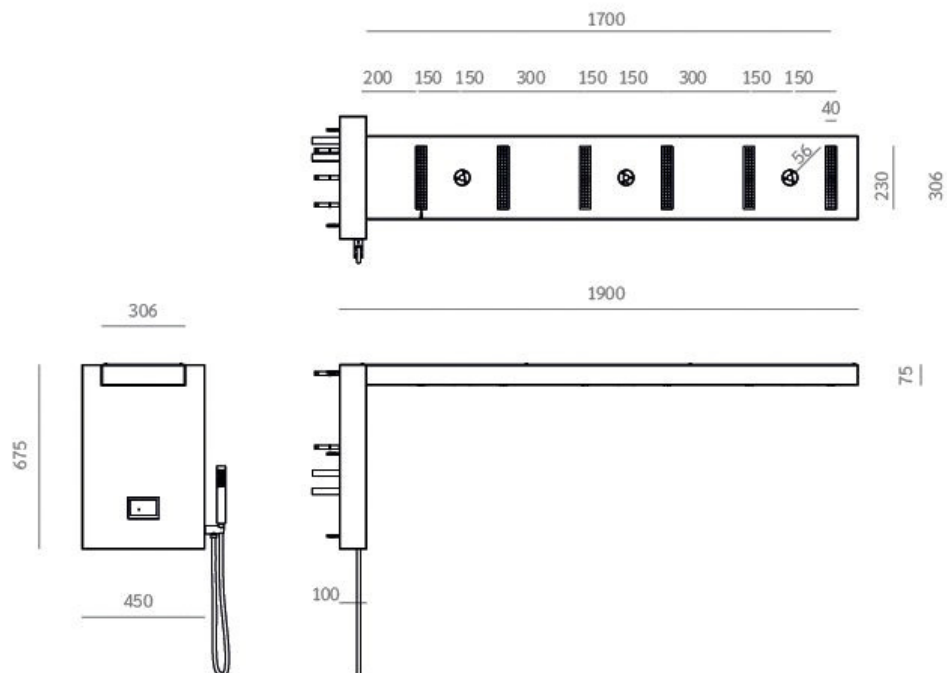

PRAYERS

USAGEAREA

RAREby aquaform

NADIR, manufactured by Aquaform, is a horizontal shower and massage system made of mirror-polished stainless steel, ceiling-mounted, with electronic water mixing, chromotherapy features, and a touch control panel for managing or manually starting 4 pre-configured programs (sport, energy, relaxation, balance).

Hydraulic features:

- "The water supply system operates with both hot and cold water.
- "Pressure 2/5 bar.
- "The recommended pressure is 3 bar.
- "For pressures higher than 5 bar, we recommend installing a pressure reducer.
- "So uk su s1cakl1 1 10 / 150C
- "Hot water temperature 1 550/ 650C
- "Optimum hot water flow 15 l/min.

Notes:

- "Draining groundwater is essential for allowing water to flow freely.
- "If the water hardness is above 15/18 degrees Fahrenheit, it is recommended to install a water softener.

Electrical characteristics:

- "Electrical supply 100-240V - 50+60Hz
- "12V transmission control panel.
- "Maximum absorption 100W
- "We recommend installing a separate RCCB (Residual Current Idle Circuit Breaker).
- "3_1kl1 RGB system.

	UNIT PRICE EURO	Code
Rare	♦♦♦♦♦♦♦♦	AF-FL036

TECHNICAL SPECIFICATIONS			
Code	Explanation	Lighting	Jets
AF-FL036	Rare	RGBW	



Spessore parete controsoffitto da 5 a 40mm

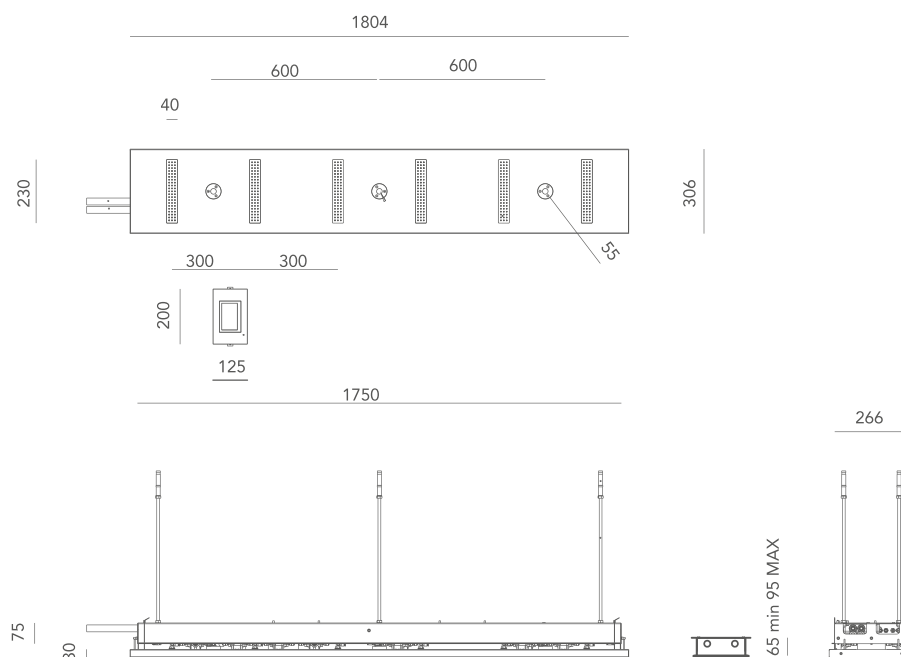

SHOER CHANGING ROOM AREA

WHITE LIGHTED DOOR

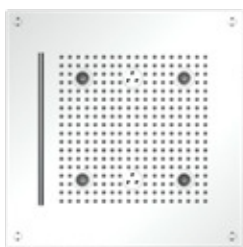

Infinity White1

White Lighting

INFINITY SEQUENCE WHITE

"Square wall-mounted box for recessed ceiling installation, 420 x 420 mm. 3 water spray patterns: 1 rain spray, 2 mist spray and 1 waterfall spray.

"It contains 4 LED 1_1k lights with chromotherapy properties.

"Ultra-bright stainless steel plate, s1v1 silicone scale inhibitor membrane.

"Ceiling depth: 150 mm.

"Water boiling point 1: 1/2" (inches)

"Operating pressure: 1.5 / 5 bar.

"Recommended pressure: 3 bar.

"Complete set including mounting system.













"The default sequence includes: Relaxation Program: Balanced water pressure and constant flow for physical well-being.

It offers a holistic relaxation experience by combining different temperatures. By blending soothing colors with chromotherapy, gentle piano music, soft rain sounds, and fresh aromas, it creates a calming atmosphere and ultimately serves as a sanctuary for restoring balance and achieving mental relaxation.

"1st e ba l1 options (must be defined when placing the order, otherwise it is not possible to add them later) will not happen):

- Sound.
- Water Aromatherapy.
- Air Aromatherapy.

	UNIT PRICE EURO	Code
Infinity White	♦♦♦♦♦♦♦♦	AF-FL012-25

TECHNICAL SPECIFICATIONS						
Code	Explanation	Lighting	Jets	Dimensions (cm)	Control	1ste e ba l1
AMNESTY-FL009-25	Infinity Series White	White	  	42 x 42	Sequence (1 du me)	  
AF-FL012-25	Infinity White1	White	  	42 x 42	Manual (3 du me)	  

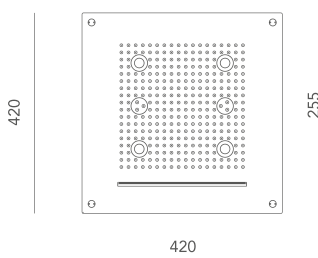

Infinity Series White /
Infinity White1

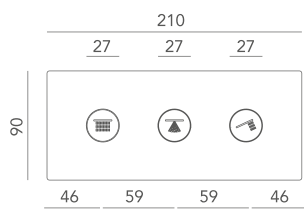

Control: Infinite White

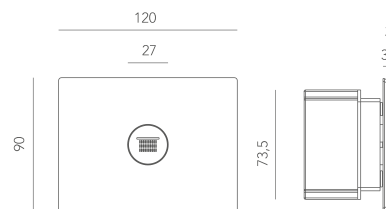

Control: Infinity Sequence White

VITANude

"Ceiling-mounted round wall-mounted shower head, Ø500 mm. 2 water spray modes: 1 rain spray and 2 fog sprays.

"Super mirror1 stainless steel plate, s1v1 silicone scale inhibitor membrane.

"Ceiling depth: 100 mm.

"Water boiling point 1: 1/2 inch

"Operating pressure: 1.5/5 bar.

"Recommended pressure: 3 bar.

"Complete set including mounting system.

"Available options (must be specified when ordering, as it is possible to add more later) will not happen):

- Sound.
- Water Aromatherapy.
- Air Aromatherapy.

	UNIT PRICE EURO	Code
Vita Naked	♦♦♦♦♦♦♦♦	AF-FL016

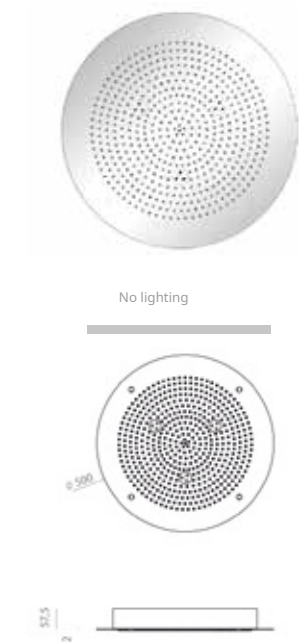

No lighting

TECHNICAL SPECIFICATIONS

Code	Explanation	Lighting	Jets	Dimensions (cm)	Control	1st EBA I1
AF-FL016	Vita Naked	-		Ø 50	Manual (2 du me)	

Control: Vita naked

INFINITY NUDE

"Square wall-mounted box for recessed ceiling installation, 420 x 420 mm. 3 water spray patterns: 1 rain spray, 2 mist spray and 1 waterfall spray.

"It contains 4 LED 1_1k lights with chromotherapy properties.

"Ultra-bright stainless steel plate, s1v1 silicone scale inhibitor membrane.

"Ceiling depth: 150 mm.

"Water boiling point 1: 1/2" (inches)

"Operating pressure: 1.5 / 5 bar.

"Recommended pressure: 3 bar.

"Complete set including mounting system.

"The default sequence includes: Relaxation Program: Balanced water pressure and constant flow for physical well-being.

It offers a holistic relaxation experience by combining different temperatures. By blending soothing colors with chromotherapy, gentle piano music, soft rain sounds, and fresh aromas, it creates a calming atmosphere and ultimately serves as a sanctuary for restoring balance and achieving mental relaxation.

"1ste e ba I1 options (must be defined when placing the order, otherwise it is not possible to add them later) will not happen):

- Sound.
- Water Aromatherapy.
- Air Aromatherapy.

	Code
Infinity Naked 1	AF-FL013-25

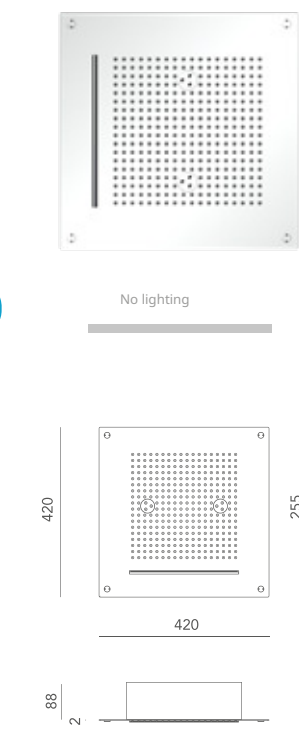

No lighting

TECHNICAL SPECIFICATIONS

Code	Explanation	Lighting	Jets	Dimensions (cm)	Control	1st EBA I1
AF-FL013-25	Infinity C1pla	kl1 1		42 x 42	Manual (3 du me)	

Control

PRAYERS

SO UK REGION



RGBW Lighting



VITACOLD

"Ceiling-mounted round wall-mounted sprayer, Ø500 mm. 2 water spray modes: 1 rain spray and 2 mist spray.

"Includes 4 LED spotlights with chromotherapy features (1_1_1).

"Super mirror1 stainless steel plate, s1v1 silicone scale inhibitor membrane.

"Ceiling depth: 100 mm.

"Water boiling point 1: 1/2 inch



"Operating pressure: 1.5 / 5 bar.

"Recommended pressure: 3 bar.

"Complete set including mounting system.

	UNIT PRICE EURO	Code
Vita So uk Du_	♦♦♦♦♦♦♦♦	AF-FL014

TECHNICAL SPECIFICATIONS

Code	Explanation	Lighting	Jets	Dimensions (cm)	Control	1ste e ba I1
AF-FL014	VITA	RGBW		Ø 50	Manual (2 du me)	

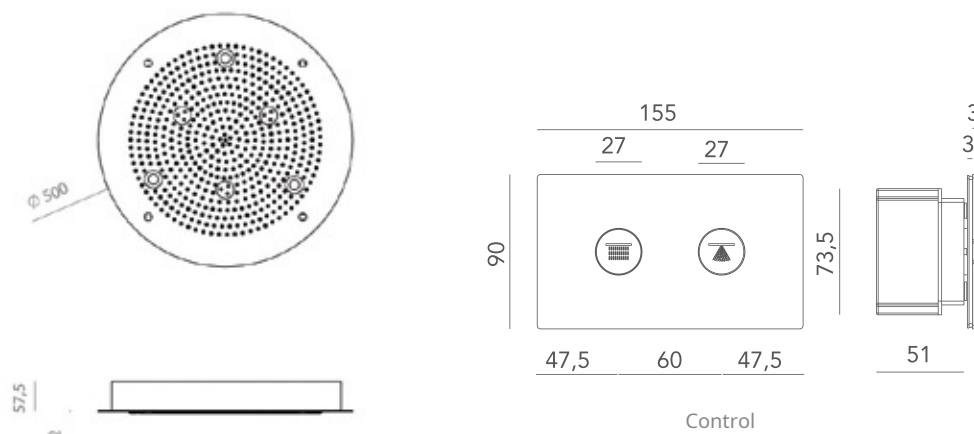

MASSAGE CHAIRS

FIXED1T

ASTRALPOOL 

VENUS

Multifunctional table with Corian surface for classic (hot) and spa (hot + wet) treatments. White metal construction. Foldable mats (storage compartment). Aromatherapy. Telescopic shower. Includes hospital-grade and easily disinfectable Corian trays.

Code

Venus Spa Massage1

N9022

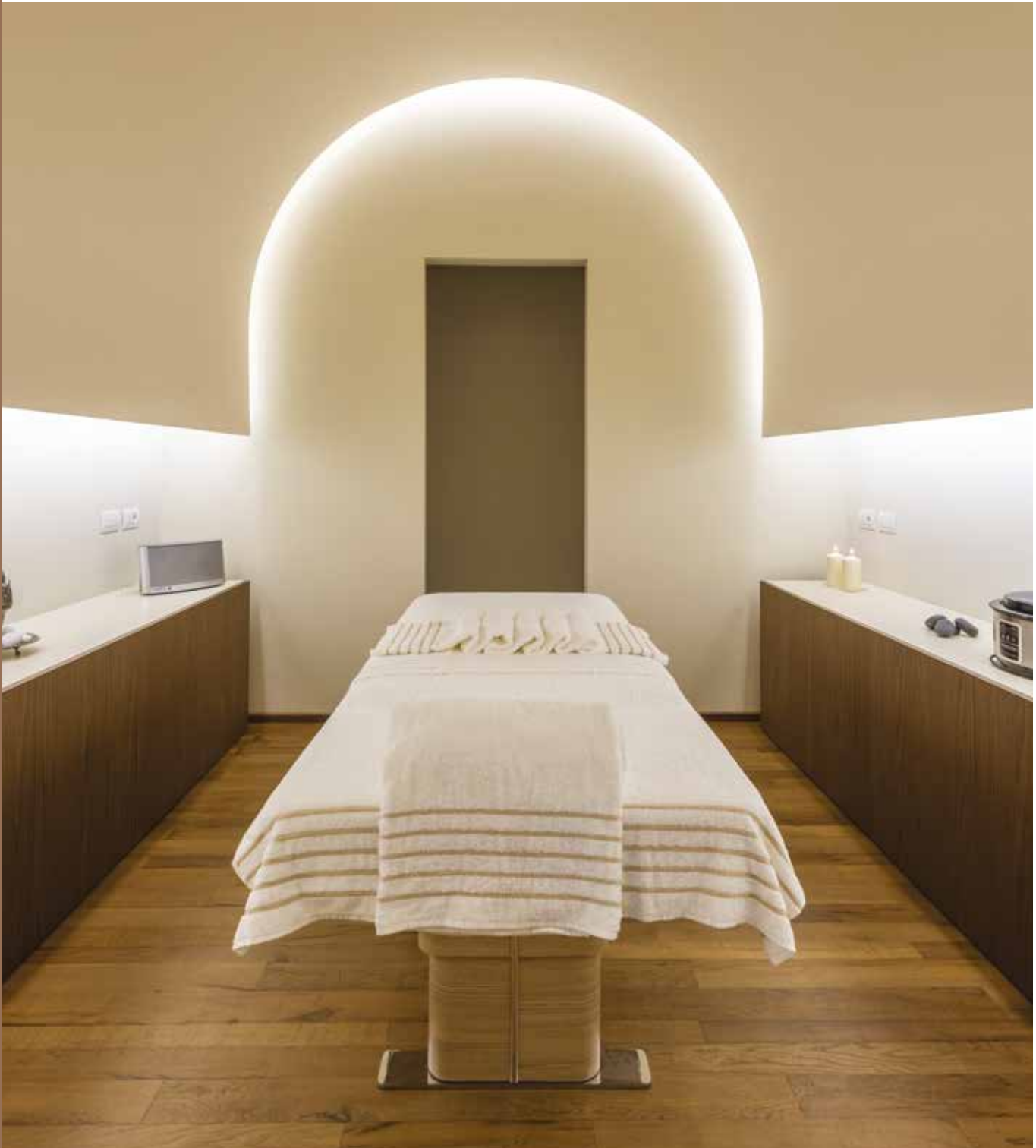

MASSAGE CHAIRS

FOLDABLE



COMFORTFLEX

ASTRALPOOL

- "Therafoam padding is extremely comfortable.
- "Luxurious, soft-textured PU upholstery
- "Adjustable backrest
- "European frame from the perspective of beech "Affinity ergonomic breathing holes i and t1pas1
- "Quick height adjustment thanks to the easy-grip butterfly screw. "A high-quality carrying bag with wheels is included for easy transport. "Face support frame and hanging armrest are included.
- "To hold the face support frame and the towel holder at both ends There are holes.
- "Reiki Style 1 final panels
- "Soft-touch carrying handles "Round corners
- "Non-slip feet
- "Excellent stability

Code

Beige Comfortflex	AFCFLEX3/B
Latte Comfortflex	AFCFLEX3/L



DELUXE

ASTRALPOOL

- "Therafoam padding is extremely comfortable.
- "Luxurious, soft-textured PU upholstery
- "European frame from the perspective of beech "Affinity ergonomic breathing holes i and t1pas1
- "Quick height adjustment thanks to the easy-grip butterfly screw. "A high-quality carrying bag with wheels is included for easy transport. "Face support frame and armrest shelf1 are included.
- "To hold the face support frame and the towel holder at both ends There are holes.
- "Reiki Style 1 final panels
- "Soft-touch carrying handles "Round corners
- "Non-slip feet
- "Excellent stability

Code

Purple Luxury	*****	AFDLX2/P
---------------	-------	----------



MARLIN

ASTRALPOOL

- "Extremely comfortable
- "Adjustable backrest
- "Therafoam sports filler
- "Lightweight, thick aluminum frame
- "H1z11 setup
- "Excellent stability
- "Clean lines
- "Reiki Style 1 final panels
- "Affinity ergonomic breathing holes and T1Pass1
- "Shaped feet for H1z11 height adjustment.
- "To hold the face support frame and the towel holder at both ends There are holes.
- "A high-quality carrying case is included.
- "Soft-touch carrying handles "Round corners
- "Non-slip feet

UNIT PRICE
EURO

Code

White Marlin	*****	AFALU4/W
Navy Marlin	*****	AFALU4/N



PRIVATE RELAXATION SUNBED

Made entirely of Scandinavian spruce and designed specifically for wet areas (not recommended for outdoor use). This easily portable chaise lounge is available in a wide range of colors.

"It is made entirely from Scandinavian spruce. "It is specifically designed for humid regions. "D1_ is not recommended for use in this space.

Code

Private Relaxation Lounger
Private Relaxation Lounger 1 Bed

44421
44422

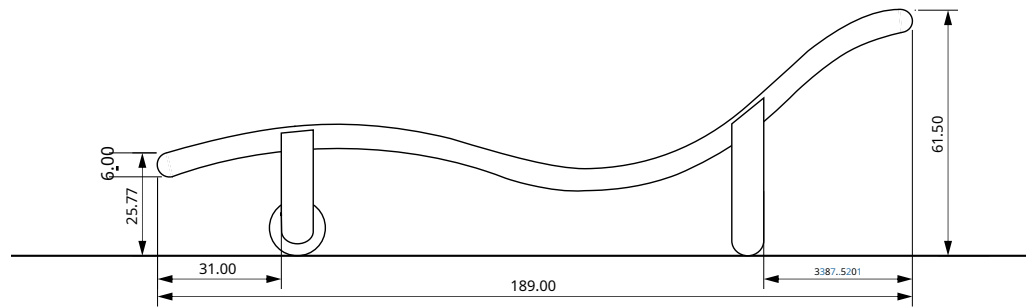



CALM CHAIR

Designed for professionals, the Calm chair is ideal for extended, uninterrupted use. This relaxation chair, engineered for muscle toning and relaxation areas, is manufactured with three infrared lamps in a fixed position to relieve localized muscle tension.

Materials

"Side surfaces: Made of plywood sheet covered with phenolic resin sheets for D1 protection (model (as ba l1)).

"The planks are made from Roko wood.

"Adjustable legs: AISI 304 stainless steel rod. Plastic support.

"Lamp: An infrared system consisting of 3 lamps placed under the tables. Operated with a switch.

"WARNING: Not suitable for areas where the ambient humidity is above 90%.

Features

"Dimensions (mm): 1245 x 806 x 663.

"Infrared lamp:

33 lamp holders.

- Model: PAR 38 IR K1rm1z1 100W / (5000h).

- Stop/start button.

- Three protective glass covers for the lamps.

- Grounded 1.5 meter connection cable.

"Ba lant1: 230 VI + Neutro.

1ste e ba l1 services are offered upon request:

"Timer for infrared solarium.

"Manual tilting system.

"Electric tilting system.

"Neck pillow 1 1.

Code

Calming - Infrared Lamp Relaxing Armchair

73901

