

SCRUBBER DRYERS

HEXA MOP SCRUBBER



NEW

HEXA MOP

Cleaning width	44 cm
Power	2 x 200 W
Surface yield	1320m ² /min
Brush rotation speed	140 rotations per minute
Weight without battery or water	21,3 kg
Dimensions (L x W x H)	52 x 45 x 120 cm
Power supply	36V Lithium-ion battery
Autonomy	1h20' maximum
Loading time	1h at 80% - 2h at 100%
Reference	z236h913731



Interchangeable batteries

Delivered with 2 standard nylon brushes and 2 batteries.
Other discs and accessories available, contact us.



**ENGINES
BRUSHLESS
POWERFUL**



**BATTERY
AND CHARGER**



**ULTRA
HANDY
AND LIGHT**



EASY TO USE



FOOT OPERATED

HEXA MATIC SCRUBBER DRYERS



HYPER HANDLING

- Ideal for cleaning swimming pool floors
- Adaptable washing brushes and disc tray
- Delivered with battery + charger + brush



Interchangeable batteries

Hexa Matic M

Cleaning width	ø 40 cm
Power/ brushing speed	175 W/ 150 rpm
Weight	34 kg
Surface yield	1400 m ² /h
Brushing	Nylon brush or pad
Detergent/recovery tank	18/ 19 L
Power supply	36 V
Reference	z236f912775



Hexa Matic XL

Cleaning width	ø 45 cm
Power/ brushing speed	300 W/ 100 rpm
Weight	90 kg
Surface yield	1600 m ² /h
Brushing	Nylon brush or pad
Detergent/recovery tank	30/ 31 L
Power supply	24 V
Reference	z236f903608



Reference more than 55 models, contact us (single brush, self-propelled).

CORDLESS AIR/WATER VACUUM



Interchangeable batteries

ON BATTERY



HEXA VAC'

NEW

- Eliminate the risk of slips and falls thanks to the absence of cables, ideal for vacuuming up puddles in barefoot areas.

Cleaning in dry or wet mode. Perfect for: vacuuming liquids, emergency leaks, lobbies, changing rooms and toilets. 40 minutes of powerful and constant cleaning, a record on the market.



Engine power	400 W
Weight	9,3 kg
Power supply	Lithium battery (Li-ion)
Water capacity	9 liters
Dust capacity	15 liters
Dimensions (LxDxH)	48 x 36 x 37,5 cm
Reference	z236f916715



Floor squeegee 50 cm

Adaptable telescopic handle.

Cleaning width	50 cm
Reference	NC

CLEANING CENTRAL



Cleaning central

Allows efficient mixing thanks to the 14 color calibrated nozzles. Dilution ratio from 0.5 to 11%. Working pressure: 1.5 to 6 bars. Working temperature: 50°C maximum.

Wall-mounted central unit with 2 products

for cleaning/rinsing/ disinfection.

Reference z237fcep2150apa00000

Trolley only for proposed model

Reference z237flb99.chm.sb10



Dinga type anti-shock gun

Multi-jet gun. Blocking trigger.

Reference qo0001n000



Flexi pro black

Expandable garden hose. ø22 mm anti-twist.

15 m Reference z188f475.500.015

30 m Reference z188f475.500.030

SPOT RANGE: ECO-FRIENDLY PROFESSIONAL VACUUM CLEANERS



WIRED SPOT 20

Use	Normal
Basin area	150 m ²
Vacuum cleaner width	40 cm
Cleaning speed	from 10 to 15 m/min
Suction power	27 m ³ /h
Cable length	18 m
Trolley	Yes (supplied)
Filtration capacity	3,1 kg
Infra red (wall detection)	No
Power supply	110 v-240 v / 24 vdc
Camera	No
Weight out of water/in water	7 kg/ 1,3 kg
Minimum water depth	30 cm
Page number	20



WIRED SPOT 50

Use	Normal
Basin area	200 m ²
Vacuum cleaner width	40 cm
Cleaning speed	from 10 to 15 m/min
Suction power	27 m ³ /h
Cable length	24 m
Trolley	Yes (supplied)
Filtration capacity	3,1 kg
Infra red (wall detection)	No
Power supply	110 v-240 v / 24 vdc
Camera	No
Weight out of water/in water	8,5 kg/ 1,8 kg
Minimum water depth	30 cm
Page number	20



WIRED SPOT 100

Use	Intensive
Basin area	300 m ²
Vacuum cleaner width	40 cm
Cleaning speed	from 10 to 15 m/min
Suction power	27 m ³ /h
Cable length	30 m
Trolley	Yes (supplied)
Filtration capacity	3,1 kg
Infra red (wall detection)	No
Power supply	110 v-240 v / 24 vdc
Camera	No
Weight out of water/in water	9 kg/ 2 kg
Minimum water depth	30 cm
Page number	20



BATTERY SPOT 150

Use	Intensive
Basin area	300 m ²
Vacuum cleaner width	40 cm
Cleaning speed	from 10 to 15 m/min
Suction power	27 m ³ /h
Cable length	5 m
Trolley	Yes (supplied)
Filtration capacity	3,1 kg
Infra red (wall detection)	2
Power supply	12V battery - 3h autonomy
Camera	No
Weight out of water/in water	9 kg/ 2 kg
Minimum water depth	30 cm
Page number	20



WIRED SPOT 200

Use	Intensive
Basin area	1000 m ²
Vacuum cleaner width	80 cm
Cleaning speed	from 10 to 15 m/min
Suction power	27 m ³ /h x 2
Cable length	40 m, 50 m optional
Trolley	Yes (supplied)
Filtration capacity	5,1 kg
Infra red (wall detection)	2
Power supply	110 v-240 v / 24 vdc
Camera	No
Weight out of water/in water	19,5 kg/ 5 kg
Minimum water depth	30 cm
Page number	21

TECHNICAL DATA

Use	
Basin area	
Vacuum cleaner width	
Cleaning speed	
Suction power	
Cable length	
Trolley	
Filtration capacity	
Infra red (wall detection)	
Power supply	
Camera	
Weight out of water/in water	
Minimum water depth	
Page number	

PEPS RANGE: COMMUNITY VACUUM CLEANERS WITH ACTIVE BRUSHING



WIRED PEPS 200

Use	Intensive
Basin area	350 m ²
Vacuum cleaner width	40 cm
Cleaning speed	from 10 to 12 m/min
Suction power	37 m ³ /h
Cable length	30 m
Trolley	In stainless steel (supplied)
Filtration capacity	4 kg of sand
Infra red (wall detection)	1 (wall detection)
Power supply	110 v-240 v / 24 vdc
Camera	No
Weight out of water/in water	14 kg/ 2 kg
Minimum water depth	15 cm
Page number	22



E-PEPS BATTERY 200

Use	Intensive
Basin area	350 m ²
Vacuum cleaner width	40 cm
Cleaning speed	from 10 to 12 m/min
Suction power	37 m ³ /h
Cable length	5 m
Trolley	In stainless steel (supplied)
Filtration capacity	4 kg of sand
Infra red (wall detection)	1 (wall detection)
Power supply	12V battery - autonomy 3h30'
Camera	No
Weight out of water/in water	14 kg/ 2 kg
Minimum water depth	15 cm (Peps) - 40 cm (battery)
Page number	22



WIRED PEPS 300 XL

Use	Intensive
Basin area	750 m ²
Vacuum cleaner width	60 cm
Cleaning speed	from 10 to 12 m/min
Suction power	37 m ³ /h
Cable length	40 m (30 m optional)
Trolley	In stainless steel (supplied)
Filtration capacity	6 kg of sand
Infra red (wall detection)	1 (wall detection)
Power supply	110 v-240 v / 24 vdc
Camera	No
Weight out of water/in water	17 kg/ 3 kg
Minimum water depth	15 cm
Page number	22



E-PEPS BATTERY 300 XL

Use	Intensive
Basin area	750 m ²
Vacuum cleaner width	60 cm
Cleaning speed	from 10 to 12 m/min
Suction power	37 m ³ /h
Cable length	5 m
Trolley	In stainless steel (supplied)
Filtration capacity	6 kg of sand
Infra red (wall detection)	1 (wall detection)
Power supply	12V battery - autonomy 3h30'
Camera	No
Weight out of water/in water	17 kg/ 3 kg
Minimum water depth	15 cm (Peps) - 40 cm (battery)
Page number	22

TECHNICAL DATA

Use	
Basin area	
Vacuum cleaner width	
Cleaning speed	
Suction power	
Cable length	
Trolley	
Filtration capacity	
Infra red (wall detection)	
Power supply	
Camera	
Weight out of water/in water	
Minimum water depth	
Page number	

TO EACH THEIR CUSTOM-MADE ROBOT

CHRONO MP3 INOX RANGE: INTENSIVE VACUUM CLEANERS FOR AQUATIC CENTERS



TECHNICAL DATA

Use
Basin area
Vacuum cleaner width
Cleaning speed
Suction power
Cable length
Trolley
Filtration capacity
Infra red (wall detection)
Power supply
Camera
Weight out of water/in water
Minimum water depth
Page number

CHRONO MP3 M

Intensive
400 m²
50 cm
from 10 to 18 m/min
50 m ³ /h
25 to 50 m
Stainless steel (4 types)
3,1 kg
2 or 4
110 v-240 v / 24 vdc
Yes (mp4)
22 kg/ 3 kg
40 cm
24

CHRONO MP3 L

Intensive
600 m²
60 cm
from 10 to 18 m/min
50 m ³ /h
25 to 50 m
Stainless steel (4 types)
3,1 kg
2 or 4
110 v-240 v / 24 vdc
Yes (mp4)
23 kg/ 3 kg
40 cm
24

CHRONO MP3 XL

Intensive
1250 m²
75 cm
from 10 to 18 m/min
50 m ³ /h
25 to 50 m
Stainless steel (4 types)
3,1 kg
2 or 4
110 v-240 v / 24 vdc
Yes (mp4)
24 kg/ 3 kg
40 cm
24

OPTION

Video camera with screen

Reference xycomp4

25

VACUUM RANGE / BIOFILM EXTRACTORS

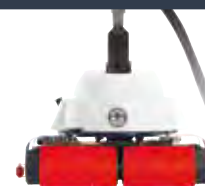

TECHNICAL DATA

Use
Basin area
Vacuum cleaner width
Cleaning speed
Suction power
Cable length
Trolley
Filtration capacity
Infra red (wall detection)
Power supply
Camera
Weight out of water/in water
Minimum water depth
Page number

DARK CLEANER

Buffer tank
—
40 cm
8 m/min
30 m ³ /h
20 m
—
External
1
110 v-240 v / 24 vdc
No
14 kg/ 2 kg
Buffer tank/40 cm
26

VIKING M

Ultra filtration
350 m²
50 cm
10 m/min
50 m ³ /h
25 to 50 m
Stainless steel pole reel (supplied)
3,1 kg
2 or 4
110 v-240 v / 24 vdc
Yes
22 kg/ 3 kg
40 cm
26

VIKING XL

Ultra filtration
800 m²
75 cm
12 m/min
50 m ³ /h
25 to 50 m
Stainless steel pole reel (supplied)
3,1 kg
2 or 4
110 v-240 v / 24 vdc
Yes
24 kg/ 3 kg
40 cm
26

BIOMATIC M

Biopool
350 m²
50 cm
from 10 to 15 m/min
50 m ³ /h
25 to 50 m
Stainless steel (2 types)
3,1 kg
2 or 4
110 v-240 v / 24 vdc
Yes
22 kg/ 3 kg
40 cm
28

BIOMATIC XL

Biopool
1500 m²
75 cm
10 m/min
50 m ³ /h
25 to 50 m
Stainless steel (2 types)
3,1 kg
2 or 4
110 v-240 v / 24 vdc
Yes
24 kg/ 3 kg
40 cm
28



A professional robot that climbs walls

The SPOT has sensor technology available to help it navigate your pool optimally.

Equipped with a radio control, it responds to the finger and the eye. With its automotive-style notched tracks and its **management system**, the SPOT is capable of **climbing slopes, climbing walls** and removing drains with complete peace of mind.

With its Multiflux axial turbo pump and its **2 different filter finesses**, nothing escapes it, from small dust to large stones.

Comes with a **professional trolley** that will allow you to store the robot, its cable and its power supply easily.



FABRIQUÉ
EN FRANCE



www.myhexagone.com



SPOT, autonomous and efficient cleaning

SPOT

POOL VACUUM



CLIMB THE WALLS

Self-floating cable with "anti-twist" system

Painted stainless steel trolley structure

Automatic mode immediate or delayed

Radio control with 30m range



2 filter bags «DUAL CLEAN» 5 and 250 µ

CLEVER NAVIGATION
WITH CONTROLLED GYROSCOPE



Brush rolls PVA or PVC



Sensor infrared

WIRED SPOT 200



SPOT 200

Mode	Floor & wall
Basin area	Up to 1250 m ²
Weight out of water/in water	19,5 kg/ 5 kg
Cable length	40 m (50m option)
Trolley	Painted stainless steel, hose reel option
Radio control	Box + smartphone app
Power supply	110 v-240 v / 24 vdc
Reference	xygppsp200

BATTERY SPOT



SPOT 150

Mode	Floor & wall
Basin area	Up to 300 m ²
Weight out of water/in water	9 kg/ 2 kg
Battery	Autonomy 3h-Charge 6h
Cable	5 m
Trolley	Painted stainless steel, battery support
Radio control	Box + smartphone app
Power supply	With battery
Reference	xygppsp150

WIRED SPOT 100



SPOT 100

Mode	Floor & wall
Basin area	Up to 350 m ²
Weight out of water/in water	9 kg/ 2 kg
Cable length	30 m
Trolley	Painted stainless steel, hose reel option
Radio control	Box + smartphone app
Power supply	110 v-240 v / 24 vdc
Reference	xygppsp100

Available in SPOT 20 and 50 version (contact us)

TROLLEY OPTION



Dispenser (standard)
k00013n000



Reel (optional)
k00044n000

PEPS, the battery or sector-powered scraper robot

AUTONOMOUS NAVIGATION SYSTEM

Optimal trajectory

45 min to clean a 25 m swimming pool.

- Equipped with infrared for detection and a gyroscope for movement.

- For flat or gently sloping pools 20° max.

- For all types of coverings (liner, tiles, concrete, stainless steel, etc.).

Technology guaranteed for regular and complete coverage.



Classic Metro Nav

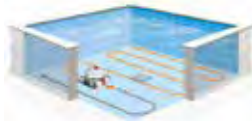

Systematic parallel lines yex001n00 (optional)

CONFIGURATOR

Trolleys

3 models.



Dispenser trolley



Battery Trolley



Optional reel trolley

Filters

- 75 microns Fine filtration f00001n001-0075
- 105 microns Classic filtration (delivered as standard) f00001n001-0105
- 250 microns Filtration for exteriors f00001n001-0250
- 1000 microns Filtration for restart f00001n001-1000



75 microns



105 microns



250 microns



1000 microns



- Cleaning speed: 10 to 12 m/min
- Suction power: 37m³/h
- Infrared: yes, wall detection

E-PEPS 200



Pool length Up to 25 m
 Cleaning width 40 cm
 Filtration capacity 4 kg of sand
 Weight out of water/in water 14 kg/ 2 kg
 Battery (autonomy) 3h30' - Charge 3h
 Trolley Stainless steel (provided)
 Power supply With battery
 Reference xypeps200bt

E-PEPS 300 XL



Pool length From 25 to 50 m
 Cleaning width 60 cm
 Filtration capacity 4 kg of sand
 Weight out of water/in water 17 kg/ 3 kg
 Battery (autonomy) 3h30' - Charge 3h
 Trolley Stainless steel (provided)
 Power supply With battery
 Reference xypeps300bt

ALSO EXISTS IN WIRED, CONTACT US

info@myhexagone.com - +33(01) 34 34 11 55



Scrapes and vacuums the bottom of the pool

Without compromise, the PEPS robot vacuum cleaner comes from more than 35 years of experience in the field of robots for public and collective swimming pools.

Robust with its stainless steel chassis, it is the ideal tool for your daily life. Equipped with a touch screen, you will choose the way you want to operate it today (manual, Magellan or systematic). With brushes rotating 3 times faster than the robot wheels, the PEPS scrapes the floor and tile joints like no other.



WORKS IN SMALL DEPTH



HANDY, SIMPLE AND LIGHT

FABRIQUÉ EN FRANCE



www.myhexagone.com



**ROBOT MOST
SOLD IN FRANCE
IN HIS
CATEGORY**

Powerful, intelligent and so efficient.

It is our most efficient and intelligent robot.

You are never number 1 by coincidence!

With cutting-edge 2024 generation technology, to make cleaning quick and precise.

Endowed with **huge power**.

Many features that make every workday easier.

A robust robot is not just a slogan like its **all stainless steel marine quality chassis guaranteed for 7 years against corrosion.**



FABRIQUÉ
EN FRANCE



www.myhexagone.com

CHRONO MP3, the reference robot

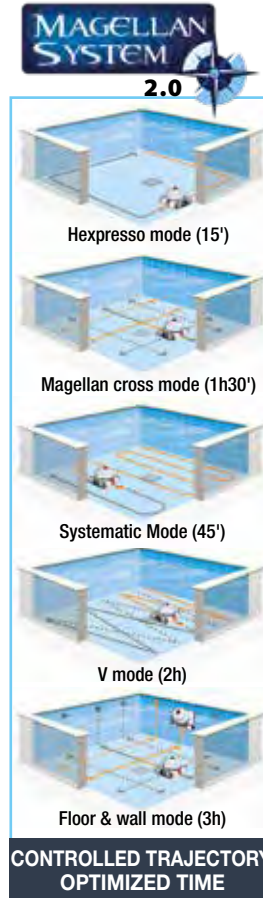
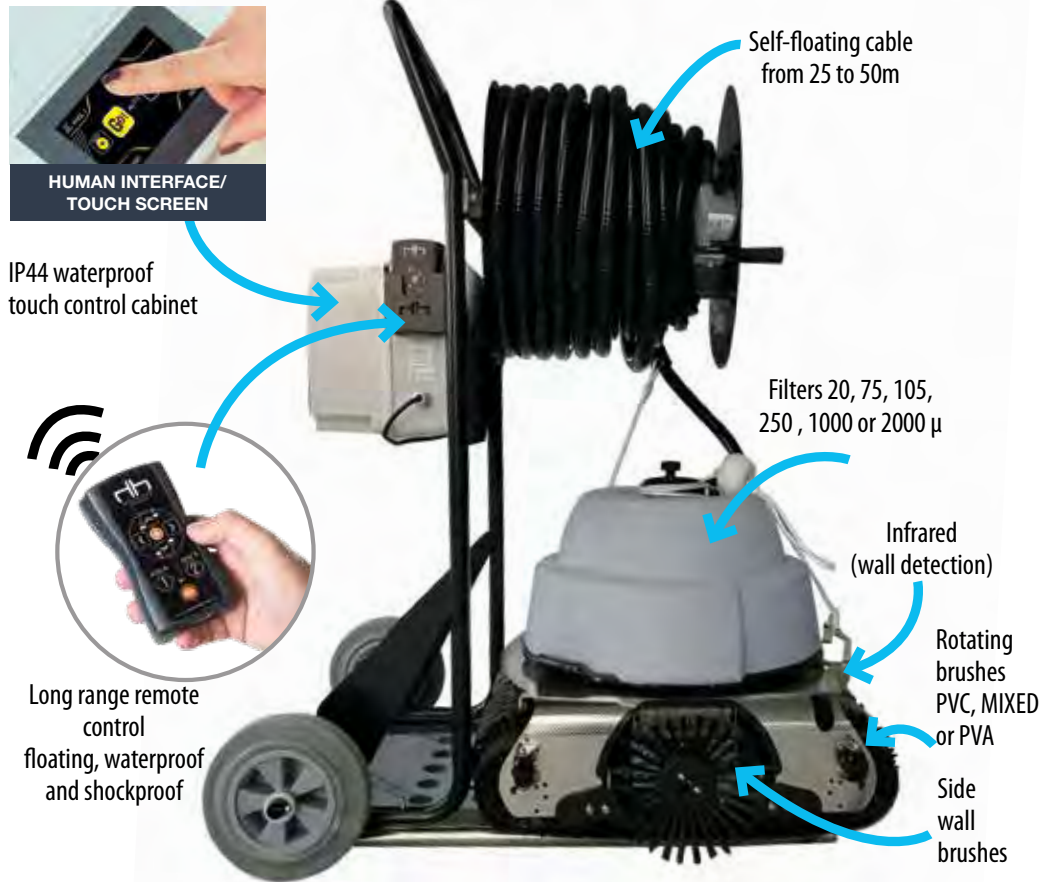

CHRONO MP3

CHRONO MP3

CONFIGURATOR

Trolleys		
Dispenser	2 forks	xzcmp3k01n01
Reel 25-32 m	Reel trolley	xzcmp3k01n02
Reel 40-50 m	Reel trolley	xzcmp3k01n03
Crane	With winch	xzcmp3k01n04

Filters		
20 µ Very fine xzcmp3f01n03	1000 µ restart xzcmp3f01n04	
75 µ Fine xzcmp3f01n07	2000 µ restart xzcmp3f01n08	
105 µ Classic xzcmp3f01n01	Leaf plate fb0002n000	
250 µ Extérieurs xzcmp3f01n02	Laminar PLEATED FILTER 50, 75 100 microns	

20 microns	75 microns	105 microns	250 microns	1000 microns	2000 microns

Brushes		
PVC For M	xzcmp3d02n03	xzcmp3d02n06 (for walls)
PVC For L	xzcmp3d02n09	xzcmp3d02n12 (for walls)
PVC For XL	xzcmp3d02n15	xzcmp3d02n18 (for walls)
MIXTE For M	xzcmp3d02n01	xzcmp3d02n04 (for walls)
MIXTE For L	xzcmp3d02n07	xzcmp3d02n10 (for walls)
MIXTE For XL	xzcmp3d02n13	xzcmp3d02n16 (for walls)
PVA For M	xzcmp3d02n02	xzcmp3d02n05 (for walls)
PVA For L	xzcmp3d02n08	xzcmp3d02n11 (for walls)
PVA For XL	xzcmp3d02n14	xzcmp3d02n17 (for walls)

SPECIAL MOVING BACKGROUND



CHRONO MP4
Camera with video display on power supply.
Reference xycmp4

CHRONO MP3 M	
Pool length	Up to 25 m
Cleaning width	50 cm
Programmable cleaning speed	10 to 18 m/min
Suction power	50 m ³ /h
Filtration capacity	3,1 kg
Weight out of water/in water	22 kg/ 3 kg
Power supply	110 v-240 v / 24 vdc
Reference	xycmp3m

CHRONO MP3 L	
Pool length	25/33 m
Cleaning width	60 cm
Programmable cleaning speed	10 to 18 m/min
Suction power	50 m ³ /h
Filtration capacity	3,1 kg
Weight out of water/in water	23 kg/ 3 kg
Power supply	110 v-240 v / 24 vdc
Reference	xycmp3l

CHRONO MP3 XL	
Pool length	50/60 m
Cleaning width	75 cm
Programmable cleaning speed	10 to 18 m/min
Suction power	50 m ³ /h
Filtration capacity	3,1 kg
Weight out of water/in water	24 kg/ 3 kg
Power supply	110 v-240 v / 24 vdc
Reference	xycmp3xl

BIOFILM

The boundaries of the nano-world:

Pool robots cannot filter at less than 5 microns, so cannot retain viruses and biofilm. It absolutely need to go back into your main filtration because your filtration knows how to do it.

Living world

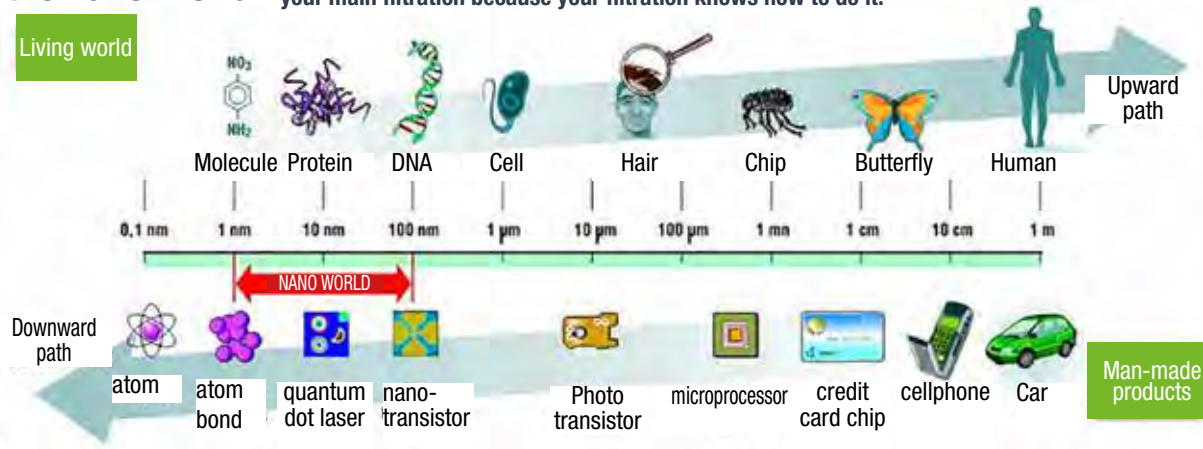

VIKING KIT FOR CHRONO

- Pumps and extracts the biofilm from the bottom 5 cm
- Reduces chemical consumption
- Allows bacteria to be extracted from the bottom of the pool
- Substantial drop in chloramine levels
- The robot becomes the armed wing of your filtration

POOL BOTTOM
Eliminates
99,8%
of
bacteria*



*According to the study carried out by Teknologisk institut, Denmark

HYBRID
VACUUM
TECHNOLOGY



VIKING M and XL

Pool length	Up to 25 m / 50/60 m
Cleaning width	50 cm / 75 cm
Cleaning speed	10 to 18 m/min
Suction power	50 m ³ /h
Filtration capacity	3,1 kg
Weight out of water/in water	24 kg/ 3 kg
Power supply	110 v-240 v / 24 vdc
Reference	Viking M
Reference	Viking XL



External pump

Speck Badu 21-50 pump installed on a crane trolley.

Optional Reference NC



Winder trolley

Hose reel trolley up to 60 m.
Reference k00011n000

Floating pipes

Diameter 38 or 50 mm.	
25 m, ø38 mm	z218h44309-25m
25 m, ø50 mm	z218h44329-25m

BUFFER TANK CLEANING

- Allows regular cleaning of the buffer tank, obligation of decree n°2021-656
- Remains permanently in the buffer tank
- Much simpler and safer for agents
- Real daily cleaning before emptying
- Fight against chloramines and deposits
- 1 infrared wall detector



DARK CLEANER

Pool length	40 cm
Cleaning width	8 m/min
Cleaning speed	30 m ³ /h
Suction power	External
Filtration capacity	14 kg/ 2 kg
Weight out of water/in water	110 v-240 v / 24 vdc
Power supply	xypeps100vkg
Reference	

WITH PUMP
EXTERNAL



External pump

External filtration motor on trolley.
Suction power: 14.4m³ /h.
Supastream 0.50 HP self-priming pump.
2 x 1½" hose adapters.
Trolley.
10m power cord with plug.
Dimensions (LxDxH) : 48 x 79,5 x 125 cm.
Reference z289h200400hex

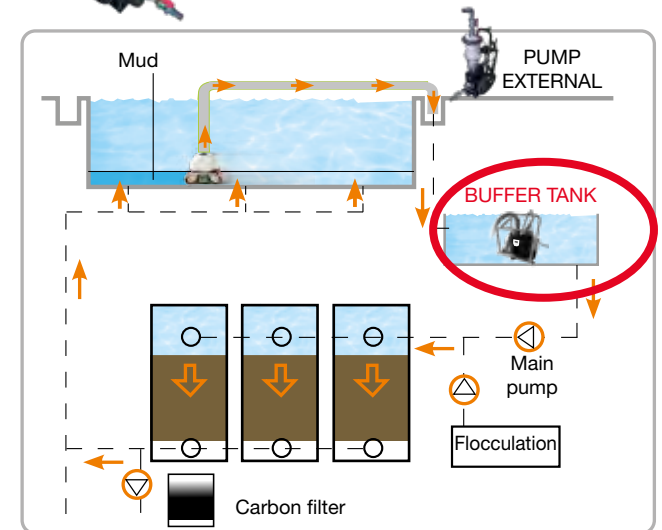

DARK CLEANER



The 1st buffer tank robot in the world

Even **invisible particles** can now be caught by our robots.

It is in the **biofilm** that bacteria, viruses and pathogens hide.

Our new technology consists of **extracting the biofilm** from the bottom of the pool to evacuate it either into **your main filtration** or **into the waste**.

By eliminating the biofilm, we prevent chlorine from fighting it and thus creating additional **chloramines and THMs**.

Working conditions are improved when cleaning the buffer tank.



ROBOT
FOR
BUFFER
TANK



The power to extract algae and leaves.

With our impressive internal and external dual pump power, the BioMatic meets the needs of natural Pools.

Operating principle: water laden with algae is pumped, pre-filtered in the robot then routed through our external filtration, blocking fine and clogging particles so that clean water can be returned to the pool.

The advantage is a clean pool and better oxygenation of the water while preserving the balance of your water without adding new water.

Its implementation is easy, the robot works autonomously and manually.



FABRIQUÉ
EN FRANCE



BIO-MATIC

Robot BIOMATIC M



Basin area	1000 m ²
Pool length	50 cm
Cleaning width	10 to 15 m/min
Suction power	50 m ³ /h
Filtration capacity	3,1 kg
Weight out of water/in water	22 kg/ 3 kg
Power supply	110 v-240 v / 24 vdc
Reference	xycmp3mbio

Robot BIOMATIC XL



Basin area	1500 m ²
Pool length	75 cm
Cleaning width	10 to 15 m/min
Suction power	50 m ³ /h
Filtration capacity	3,1 kg
Weight out of water/in water	24 kg/ 3 kg
Power supply	110 v-240 v / 24 vdc
Reference	xycmp3xlbio

DOUBLE FILTRATION



BIOMATIC, the robot for natural ponds

BIOMATIC

FILTRATION OPTIONS

OPTION N°1



TOP 1 FILTER Filter

Reference fk0003chrn000

OPTION N°2

EXTERNAL FORK



ROBOT WITH PREFILTER

EXTERNAL PUMP ON ITS TROLLEY

FORK WITH 4 ULTRAFINE FILTERS



KIT BIO-MATIC System

Robot pre-filter kit + external pump + fork with 4 filters. (Robot sold separately).

With our 4 specific bags, you can choose the mesh size of 20, 75, 105, 250, 1000 or 2000 microns.

Delivered with a 5 m hose for outlet and a 25 to 50 m hose for suction.

Other pipe lengths, contact us.

Reference fk0005chrn000

OPTION N°3 EXTERNAL BIO FILTER



XXL filter (for very dirty pond)

Chassis	Stainless steel
Filter fineness	20 microns
Power	1400 W, 24000l/h
Weight	53 kg
Reference	z418fr10

BIOMATIC CONFIGURATOR



M chassis

Cleaning width 50 cm.

Reference zzcmp3e00n01



XL chassis

Cleaning width 75 cm.

Reference zzcmp3e00n03

Cables and suction pipes ø50 mm

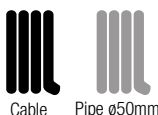

Floating cable

25 m	zxcmp3c01n02
32 m	zxcmp3c01n04
40 m	zxcmp3c01n05
50 m	zxcmp3c01n06
60 m	zxcmp3c01n07

Floating hose

25 m	cvka25n002
30 m	cvka32n002
40 m	cvka40n002
50 m	cvka50n002
60 m	cvka60n002



Discharge pipes

Diameter 38 or 50 mm.

25 m, ø38 mm	Reference z218h44309-25m
25 m, ø50 mm	Reference z218h44329-25m



Trolleys

Reel 25-32 m Reel trolley	zxcmp3k01n02
Reel 40-50 m Reel trolley	zxcmp3k01n03
Crane with winch	zxcmp3k01n04



Winder trolley

Hose reel trolley up to 60 m.

Reference k00011n000



Bio-Matic connector

Reinforced PVC pipe.

Reference fk0004ch2n000



Robot pre-filter

1000/2000 microns
Reference zxcmp3f01n04/ zxcmp3f01n08



Leaf plate

1 cm Reference fb0002n000

SURFACE SKIMMER



NEW

SKIMBOT surface skimmer

Clear water circuit Water current loaded generated

The SKIMBOT is a suction pump for floating waste, macro-waste and hydrocarbons.

A powerful pump draws in clear water to create a surface current that sucks up waste and stores it in a net. Operates continuously, without personnel.

Suction flow: 26m³/h. Waste storage: 150 L.

Reference

NC

LINEO ORGANIC POND

- Waterproof battery-powered roller brush
- Scrubs and vacuums at the same time
- Ideal for scrubbing the bottom of biological ponds.
- Different types of brushes optional, contact us...



ORGANIC LINEO XXL

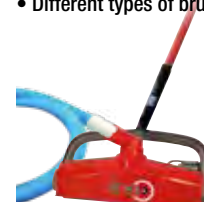

*Comes with a black roller

Brush size
Power supply
Telescopic pole
Battery charger
Power/Autonomy
Weight
Brushing/Cleaning
Reference

Width 44 cm
24V Li-ion battery
250 to 500 cm
Serial
120 tours/min./ >2h to 3h
6 kg
*Adjustable nylon roller
xlineobs44n000



TRIANGULAR BRUSH

Quick Vac Bio Vacuum Cleaner

Power supply
Telescopic pole
Weight
Brushing/Cleaning
Dimensions (LxDxH)
Reference

110v-240V
250 to 500 cm
32,5 kg
Triangular brush
85 x 46 x 62 cm
z260forultra

CHOOSE OUR

HEXABOX

OUR LONG-TERM FINANCING SOLUTIONS,
MAINTENANCE INCLUDED

**LLD 48 OR 60
MONTH**

**99%
OF CUSTOMERS
SATISFIED**

info@myhexagone.com - +33(01) 34 34 11 55

FULL SERVICE RENTAL CONTRACTS

ANNUAL OR SEASONAL OPENING



OPT FOR COMPLETE AND CLEAR RENTAL AND MAINTENANCE CONTRACTS

It is essential that you have **understandable and complete information on the guarantees** of your rental and/or maintenance contracts.

Hexagone has opted for **readability** and **maximum simplification** with:

- **unique coverage** to guarantee you **all the parts of the robot** whatever the breakdown incurred during the contract years (excluding breakage);
- an **unlimited labor and travel**, package, meaning that we travel to site as many times as necessary with the “HexaBox” contract;
- The insurance of a **loan robot** if you are unable to repair the breakdown within 72 hours.

Choose a company that offers **complete, clear and readable contracts**, this is the assurance of a clean swimming pool and peace of mind!

HEXABOX ANNUAL FULL SERVICE

At any time, you have the guarantee that your robot will be ready for use and you can anticipate your costs well in advance.

LLD OFFER of 48 or 60 months with MAINTENANCE INCLUDED:

- Equipment of your choice,
- After-sales service included with unlimited parts, labor and travel,
- Loan material if necessary.

The advantages:

- Guaranteed peace of mind thanks to the payment of monthly rents with maintenance included,
- A controlled budget thanks to fixed monthly rents with no surprises,
- Support from our technicians to prevent abnormal wear or misuse of your robots during the duration of the contract.

HEXABOX SEASON FULL SERVICE

SEASONAL RENTAL WITH MAINTENANCE

90 or 150 days of seasonal rental:

You have a seasonal swimming pool, which only works in summer, HEXAGONE **has the solution**.

- A rental of 3/4/5 or 6 MONTHS for 4 YEARS!
- We ensure delivery, commissioning and maintenance by our regional technician.
- At the end of the season, we take the robot back to put it into operation “wintering” in our workshops, after having checked, revised and controlled it.
- From the start of the season, we re-deliver your robot to you, so throughout the winter season the robot remains in our workshops protected from bad weather!
- If you change personnel, no problem, our regional technician, your partner, remains at your disposal to provide instructions for launching and operating the robot.

REPAIR YOUR ROBOT

CONTRACT OF HEXAFIX MAINTENANCE

ALL INCLUSIVE (FULL SERVICE):

- 1.** Telephone assistance 5 days a week, from 7:30 a.m. to 6:00 p.m.,
- 2.** Unlimited on-site interventions,
- 3.** **DAWN INTERVENTION, FROM 5:30 A.M. TO 8:00 A.M. IN YOUR POOL,**
- 4.** Parts, labor and travel fully covered unlimited under the Hexafix contract, excluding breakage,
- 5.** Totally free workshop-factory return,
- 6.** Equipment guaranteed for life during the duration of the contract,
- 7.** Loan robot during prolonged immobilization,
- 8.** Permanent support thanks to a range training and services on site or in the factory workshop,
- 9.** Fixed annual lump sum price, respected budget.

INTERVENTION ALL OVER FRANCE



A FLEET OF WORKSHOP VEHICLES FOR TECHNICIANS AND SALESMEN RENEWED EVERY 2 YEARS

for a reduced carbon footprint with systematic reduction of CO2 emissions to Euro 6 standards, also including 1 100% electric vehicle.

NO TO OBSOLESCENCE SCHEDULED



REPAIR IS: EFFICIENT, ECONOMIC & ECOLOGICAL

95% of our robots are repairable on site. Speed of interventions. Availability of spare parts with truck stock managed by SAP. A 100% PRO quality service, management of the technicians' collaborative calendar.

QUALIFYING TRAINING TECHNICIANS



COMMISSIONING INCLUDED IN THE PURCHASE OF THE ROBOT (3 LEVELS OF TRAINING)

We organize training for swimming pool staff on the use and maintenance of the machine. Small maintenance only requires a few minutes per week and a self-diagnosis is included in each machine.

REMOTE DIAGNOSTICS AND TUTORIALS WITH VISIOFIX

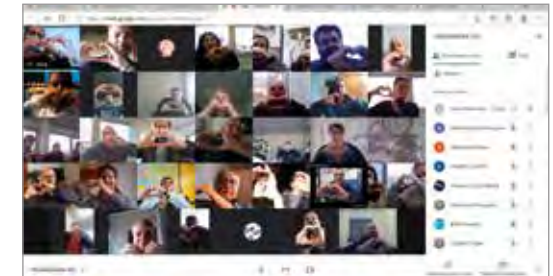

WITH VISIO FIX, HEXAGONE MANUFACTURE CUSTOMERS CAN CHAT VIA WEBCAM WITH A CONSULTING TECHNICIAN

This videoconferencing service enhances the understanding of the customer problem and promotes decision-making by the consulting technician on the course of action to take. Accessible both on computer and smartphone.

ON SITE WITH OUR SERVICE

NATIONAL ASSISTANCE, LOCAL PRESENCE

No breakdown between us!
Our advisors support you non-stop from your request until the end of the intervention

RESPECT THE ENVIRONMENT

COLLECTION, RECYCLING, RECOVERY, TRACEABILITY

- With Hexagone and its unique after-sales service we reprocess our motors, pumps, electronic cards and cables for a second life in 85% of cases.
- The stainless steel chassis and trolley as well as all stainless steel parts are recycled.



SHOWER CHAIR

UNIBLUE WHEELCHAIR 5

Regular

150 kg

13 kg

2 large

2 small

Aluminum-Stainless Steel

Plastic fabric

Without

None

93 x 43 x 96 cm

36

UNIBLUE DESIGN WHEELCHAIR 4 5

Intensive

150 kg

20 kg

2 large

2 small

Thermoplastic

Thermoplastic

Without

None

67 x 82 x 105 cm

36

UNIKALO 50 WHEELCHAIR 1 4

Occasional

130 kg

25 kg

Inflatable and floating

—

Stainless steel - Epoxy painting

Hard shell

Without

None

100 x 72,3 x 110 cm

36

UNIKALO BEACH 4

Regular

113 kg

27 kg

Inflatables ø 41 cm

1

Aluminum-Stainless Steel

Fabric

Without

None

152 x 107 x 127 cm

36

TECHNICAL DATA

Use
Max lifting load
Weight
Rear wheels
Front wheels
Structure
Seat
System
Seat course
Power supply
Dimensions (WxDxH)
Page number

MANUAL WINCH TROLLEY

UNIKART MANUAL A1 A2

Regular

136 kg

260 kg (with counterweight)

2

2

Painted stainless steel

Polypropylene

Pantograph (winch)

80 cm

None

76 x 130 x 145 cm

38

ELECTRIC ACTUATOR TROLLEY

UNIKART COMPACT B1

Regular

136 kg

200 kg (with counterweight)

2

2

Painted stainless steel

Polypropylene

Pantograph (motorized actuator)

45 cm

24 volt battery

65 x 120 x 144,5 cm

38

UNIKART MOTORIZED B1 B2

Intensive

136 kg

260 kg (with counterweight)

2

2

Painted stainless steel

Polypropylene

Pantograph (motorized actuator)

65 cm

24 volt battery

65 x 120 x 170 cm

38

ASSISTED / AUTONOMOUS TROLLEY

UNIKART ASSIST B1 C1

Autonomous

150 kg

260 kg

2

2

Stainless steel

Polypropylene

Motorized

138 cm

24 volt battery

67 x 134 x 140 cm

38

UNIKART DESIGN B1

Autonomous

136 kg

300 kg

2

2

Aluminium/Stainless steel

Polypropylene

Motorized

91 cm

24 volt battery

78 x 251 x 150 cm

38

TECHNICAL DATA

Use
Max lifting load
Weight
Rear wheels
Front wheels
Structure
Seat
System
Seat course
Power supply
Dimensions (WxDxH)
Page number

YOUR NEEDS AND OUR

- A **MANUAL**
(light to regular use)
- B **Battery-powered ELECTRIC ACTUATOR**
(regular to intense use)
- C **MOTORIZED ASSISTED TRAVEL**
(regular use with beach distance)
- D **AUTONOMOUS ROTATING CRANE**
(light to intense use without supervision)
- E **HYDRAULIC**
(light to intense use without supervision)

TO EACH HIS OWN PRM LAUNCH

CORRESPONDENCES

- 1** INFINITY POOL (short arm)
- 2** MARGELLE SWIMMING POOL (long arm)
- 3** ABOVE GROUND POOL (Spa, above ground pool)
- 4** GENTLE SLOPE BEACH
- 5** SHOWER

FIXED CRANE



TECHNICAL DATA

Use
Max lifting load
Weight
Rear wheels
Front wheels
Structure
Seat
System
Seat course
Power supply
Dimensions (WxDxH)
Page number



UNIFIX MANUAL A1 A2
Regular
150 kg
50 kg
—
—
Galvanized steel
Hammock (hard seat optional)
Manual actuator
130 cm
None
137 x 30 x 141 cm
42



UNIFIX MOTORIZED XD B1 B2
Intensive
150 kg
60 kg
—
—
Galvanized steel
Hammock (hard seat optional)
Motorized actuator
130 cm
1 battery
137 x 30 x 141 cm
42

FIXED AUTONOMOUS DEVICE



UNIROCK MOTORIZED B1 B2
Autonomous
136 kg
50 kg
—
—
Painted stainless steel
Polypropylene
Motorized
100 cm
1 battery
68 x 129 x 122 cm
40



UNIJET HYDRAULIC E1 E2
Autonomous
136 kg
55 kg
2 suction cups
2 small
Painted 316L stainless steel
Polypropylene
Hydraulic
120 cm
Hydraulic (3 bars mini)
70 x 70 x (185 low),(264 high)
40

LAUNCHING FOR ABOVE GROUND POOL/SPA



TECHNICAL DATA

Use
Max lifting load
Weight
Structure/ Seat
System
High seat level
Power supply
Dimensions
Page number



UNIKART HI/LO D1 D2 D3
Intensive
136 kg
542 kg
Aluminum-Stainless steel/ Polypropylene
Motorized
160 cm
24 volt battery
101 x 121 x 152 cm
39



UNIFIX HI/LO D1 D2 D3
Intensive
136 kg
124 kg
Aluminium-Inox/ Polypropylène
Motorized
180 cm
24 volt battery
101 x 120 x 152 cm
40

ACCESS PATH - STAIRS - LADDER



BEACH WALKWAY
Occasional
—
—
33,3 x 8,3 cm - thickness 1,5 cm
36



STAINLESS STEEL STAIRS
Intensive
—
Stainless steel
Plastic
None
None
Width 50 cm
43



STAINLESS STEEL LADDER
Intensive
—
Stainless steel
Plastic or stainless steel
None
None
Width 50 cm
43

You are not decided, you want another product, do not hesitate to contact us...

info@myhexagone.com - +33(01) 34 34 11 55

SHOWER CHAIRS



UNIBLUE wheelchair 5

Maximum user weight	Up to 150 kg
Weight	13 kg
Dimensions (LxDxH)	93 x 43 x 96 cm
Structure	Stainless aluminum
Seat	Plastic fabrics
Rear wheels/front wheels	2 large/2 small
Reference	z516f302018



UNIBLUE Design wheelchair 100% PVC 5

Maximum user weight	Up to 150 kg
Weight	20 kg
Dimensions (LxDxH)	67 x 82 x 105 cm
Structure/ Seat	100% thermoplastic
Rear wheels/front wheels	170,5 cm
Reference	z200f715025

BEACH CHAIR



Unikalo BEACH 4

Maximum user weight	Up to 113 kg
Weight	27 kg
Power supply	None
Rear wheels	Inflatables ø 41 cm
Front wheels	1
Dimensions (LxDxH)	152 x 107 x 127 cm
Structure/ Seat	Aluminum-Stainless Steel/Tissue
Reference	z350fwaterwheels

ACCESS PATH



Beach walkway

Ideal for facilitating access to the beach for strollers, wheelchairs for the elderly and the disabled. Ideal for beaches, campsites, bathing establishments, parking areas, gardens, kiosks, pedestrian crossings, greenhouses, emergency tents for civil protection, etc... Very robust, made of PP resistant to atmospheric agents, salt water and UV rays. Composed of elements measuring 333x83 mm and thickness 15 mm.



Available in 10 colors from stock. Consult us.

Reference

z113ffl.5000ral

UNIKALO 50, exceptional floatability



Ideal for infinity pool

POOL ACCESS AND EXIT WITH ASSISTANCE SIMPLE AND EASY



UNIKALO 50



UNIKALO 50 wheelchair 1 4

Maximum user weight	UP to 130 kg
Weight	25 kg
Rear wheels	Inflatable and floating
Dimensions (LxDxH)	100 x 72,3 x 110 cm
Structure/ Seat	Marine stainless steel/ Hard shell
Reference	xuni050n001

ECONOMIC!

- Thanks to 2 large inflatable wheels, the chair floats when launching.
- Designed for access to water for PRMs in a seated position (public or private infinity pool, hotel or campsite).

PRM ARMCHAIRS



UNIKALO 50, POOL ACCESS CHAIR FOR PRM

SIMPLIFIED LAUNCHING SOLUTION

- Ideal for hotels, campsites and Commercial pools
 - Avoids the investment of heavy PRM equipment
 - Light and easy to use
 - Ideal for infinity pool
 - The chair floats during launching
- ...and Archimedes' law does the rest!**



www.myhexagone.com

FABRIQUÉ
EN FRANCE



UNIKART COMPACT, MOBILE LAUNCHING TROLLEY

FROM THE LOCKER ROOM TO THE POOL

- Space-saving and easy to move
- Fast, no fixing to the ground
- Safe and practical for reception and launching of PRM
Approved by APAVE.



FABRIQUÉ
EN FRANCE



UNIKART COMPACT, and your swimming pool becomes accessible to PRMs

MOBILE



MOBILE LIFT

Unikart with electric actuator **B1**

Max lifting load	Up to 136 kg
Weight with counterweight	200 kg
Power supply	24 volt battery
Dimensions (LxDxH)	65 x 120 x 144,5 cm
Trolley/ Seat System	Painted stainless steel/polypropylene
Low seat level Reference	Pantograph (motorized actuator) 45 cm xunicptmn000

UNIKART ACCESSORIES



Quadriplegic harness option

Head, thorax, wrist, hip attachments.

qqk001n000



Protective cover for UNIKART

Dimensions (LxDxH) : 67 x 70 x 118 cm

ka0292n000

UNIKART RANGE

A LAUNCH FOR EVERY SITUATION

- A** **MANUAL**
(light to regular use)
- B** **Battery-powered ELECTRIC ACTUATOR**
(regular to intense use)
- C** **MOTORIZED ASSISTED TRAVEL**
(regular use with beach distance)
- D** **AUTONOMOUS ROTATING CRANE**
(light to intense use without supervision)

- 1** **INFINITY POOL**
(short arm)
- 2** **SWIMMING POOL COPING**
(long arm)
- 3** **ABOVE GROUND POOL Spa**



UNIKART CLASSIC



- A1**
- A2**

Reference xunin008 Manual winch

- Maximum lifting load: 136 kg

- B1**
- B2**

Reference xunimpn000 Electric actuator

UNIKART COMPACT



- B1**

- Maximum lifting load: 136 kg
 - Number of cycles: 20
- Reference xunicptmn000

UNIKART DESIGN



- D1**

- Maximum lifting load: 136 kg
 - Number of cycles: 50
- Reference z189fi-swim2-s

UNIKART ASSIST



- C1**

- Maximum lifting load: 145 kg
 - Number of cycles: 50
- Reference z136fpp(01t)

UNIKART HI/LO **SR Smith**



- D1**

- Maximum lifting load: 136 kg

- D2**

- D3**

Reference Z797f252-0000

HYDRAULIC ELEVATOR

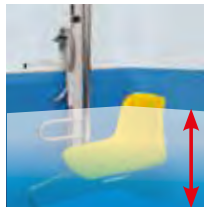

Autonomous hydraulique UNIJET E1

Max lifting load	Up to 136 kg
Weight	55 kg
Power supply	Hydraulic (3 bars mini)
Dimensions (LxPxH)	70 x 70 x (185 low), (264 high)
Structure/ Seat	Painted 316L stainless steel/ polypropylene
Low seat level	120 cm
Right rotation 180°	xujetn002
Left rotation 150°	xujetppn001
Removable footrest option	kj0015n000
Option all electropolished stainless steel	xujepn002

AUTONOMOUS SPA

Unifix autonomous SPA D1 D2 D3

Max lifting load	Up to 136 kg
Weight with counterweight	124 kg
Power supply	24 volt battery
Dimensions (LxDxH)	101 x 120 x 152 cm
System	Motorized
High seat level	180 cm
Reference	Z797f375-0000eu



UNIROCK, to rediscover the pleasure of swimming at home or at the hotel

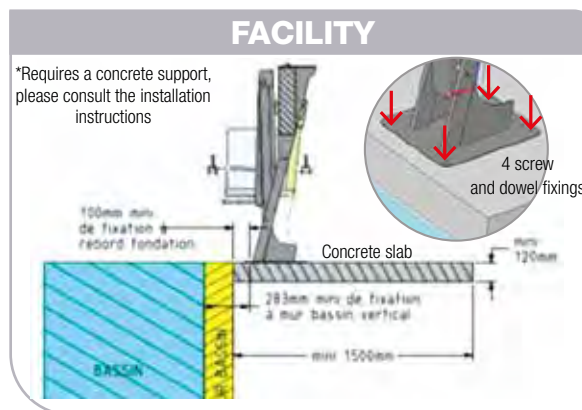

AQUATIC LIFT

UNIROCK on battery B1 B2

Max lifting load	Up to 136 kg
Weight with counterweight	50 kg
Power supply	1 battery
Dimensions (LxDxH)	68 x 129 x 122 cm
Structure/ Seat	Painted stainless steel/polypropylene
System	Motorized
Low seat level	100 cm
Reference	xunirckn000





UNIROCK, AQUATIC LIFT

FIXED AND AUTONOMOUS SYSTEM

- Ideal for Senior and PRM
- Very compact, takes up little space
- Autonomous on battery

**Designed for the comfort and safety
of PRM in complete autonomy.**



FABRIQUÉ
EN FRANCE



www.myhexagone.com

UNIFIX, THE 360° ROTATING CRANE

SIMPLE AND ECONOMIC

- Ideal for swimming pools and inground spas
- Battery-powered motorized actuator option
- 360° rotating column by attendant
- With hammock or hard seat
- **Foldable and lightweight**



ECO MANUAL
ACTUATOR



UNIFIX, to combine simplicity and security

FIXED

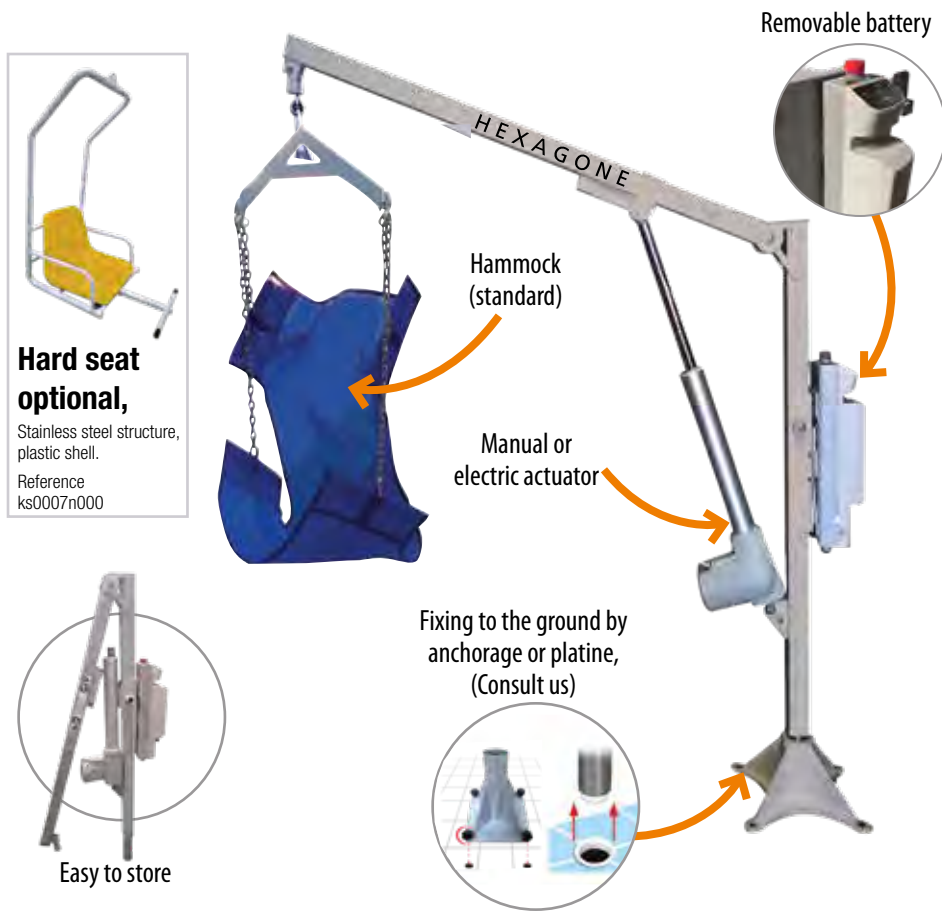

Hard seat optional,
Stainless steel structure,
plastic shell.
Reference
ks0007n000

FIXED ROTATING CRANE

Unifix manual eco **A1** **A2**

Max lifting load	Up to 150 kg
Weight	50 kg
Power supply	None
Dimensions (LxDxH)	137 x 30 x 141 cm
Stem/ Seat	Galvanized steel/ hammock
Low seat level	130 cm
Reference	Platine xufivr30n000
Reference	Anchorage xufivr31n000

Motorized Unifix XD **B1** **B2**

Max lifting load	Up to 150 kg
Weight	60 kg
Power supply	1 battery
Dimensions (LxDxH)	137 x 30 x 141 cm
Stem/ Seat	Galvanized steel/ hammock
Low seat level	130 cm
Reference	Platine xufim30n000
Reference	Anchorage xufim31n000

EASY AND QUICK ASCENT/DESCENT

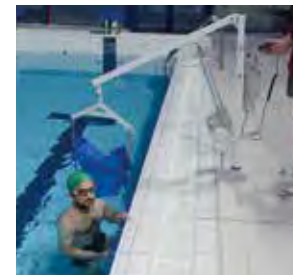
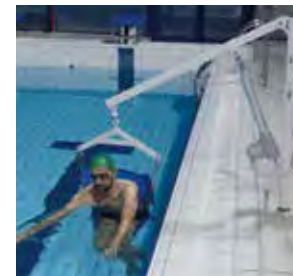

STAIRS/STAINLESS STEEL LADDER

Staircase width 50 cm

Width of 50 cm between the two handrails.
Made of stainless steel Ø 43 mm AISI-316 polished tube.
Plastic steps with non-slip surface.
Supplied with fixing anchor (with connection to an equipotential bond).
Height adjustable.
Easy to install.
Reference z218f00119

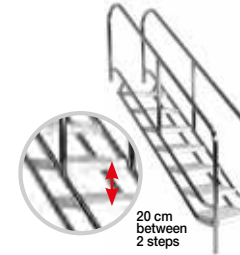

AVAILABLE IN 4, 5, 6, 7 AND 8 STEPS

Standard ladder

Tube Ø 43 mm in polished stainless steel.
L.50 cm.
3-4-5 steps.
Other models, contact us.
Reference NC



NON-SLIP STEP

Anti-slip walking system

The only non-slip safety system for swimming pool ladders. Safe, innovative, non-slip.

- QUICK AND EASY ASSEMBLY
 - NO TOOLS NEEDED
 - SUITABLE FOR MOST MARKETS
- No need for ladder disassembly. Rough, non-slip texture guarantees maximum grip for the feet.
6 safety tabs. Adapts and attaches perfectly to the step.
Additional stability. Ergonomic design.
Reference NC



In 3 simple steps:

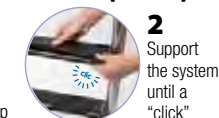
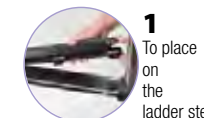

Stainless steel cleaner

Inox-Star is a special high viscosity acid concentrate for cleaning and maintaining stainless steel surfaces.

1 Liter	Reference	z612f2056
16 liters	Reference	z612f1951

EVERYTHING FOR THE LIFEGUARD:

CHAIRS/PLATFORMS

LIFEGUARD PLASTIC CHAIRS

Made from recycled polypropylene. Maximum load 130 kg.



1 steps
Seat height **80 cm**



2 steps
Seat height **100 cm**



3 steps
Seat height **127 cm**



4 steps
Seat height **152 cm**



5 steps
Seat height **183 cm**

LIFEGUARD ALU CHAIRS

In aluminium. Maximum load 100 kg.



6 steps
Seat height **190 cm**

CHAIRS/ PLATFORMS OPTIONS



Beach umbrella

Transport wheels for all HEXA CHAIR



LIFEGUARD PLATFORMS

Made from recycled polypropylene or stainless steel. Maximum load 180 kg.



3 steps
Seat height **150 cm**



Malibu
Seat height **150 cm**



Hexatour
Seat height **100 cm**



Hexatour
Seat height **40 cm**

CONTROL TOWER

In wood or stainless steel. Standard or tailor-made



Wooden-style
Seat height **143 cm**



Wooden cabin
Custom made NC



Friedel
Seat height **150 cm**

You are not decided, you want one

SUPERVISION, RESCUE AND COMPETITION

EMERGENCY/SAFETY

FIRST AID KIT



Kit of 1 first aid Foldable stretcher Defibrillator

SIGNAGE

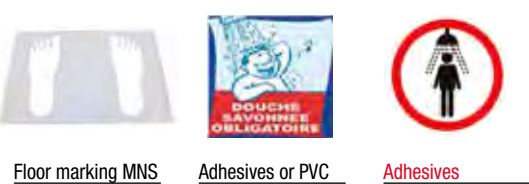

Floor marking MNS Adhesives or PVC Adhesives

POOL FURNITURE

PVC STORAGE



PVC benches PVC shelves PVC trolleys/bins

BUOYS/POLE



Plastic buoy Buoy box Emergency pole

SECU-RELAY/COMMUNICATION KIT



Panic button Shower alarm Talkie walkie

LOUNGE CHAIRS/UMBRELLAS

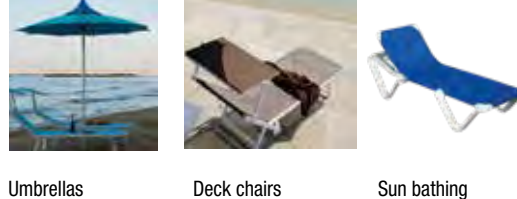

Umbrellas Deck chairs Sun bathing

SWIM LANES

COMPETITION & TRAINING



Hexastar 100
ø 100 cm Hexastar 150
ø 150 cm Separation line
Float 80 x 50 cm

REEL & ACCESSORIES

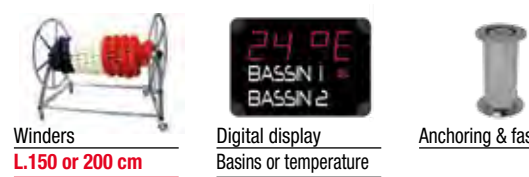

Winders
L.150 or 200 cm Digital display
Basins or temperature Anchoring & fasteners



Lane distributor Starting point Pad, Pull Boy, fines

other product, do not hesitate to contact us...

info@myhexagone.com - 01 34 34 11 55

LIFEGUARD

HEXA CHAIR, SUPERVISION CHAIR ERGONOMIC, NON-SLIP STEPS

IMPROVE THE SECURITY IMAGE OF YOUR FACILITY

- 1, 2, 3 or 4 steps, these chairs are adaptable to water depths of your ponds
 - Ultra-resistant, very high stability and floating
 - Ideal seat inclination for good back support
- N°1 chairs in the USA!**

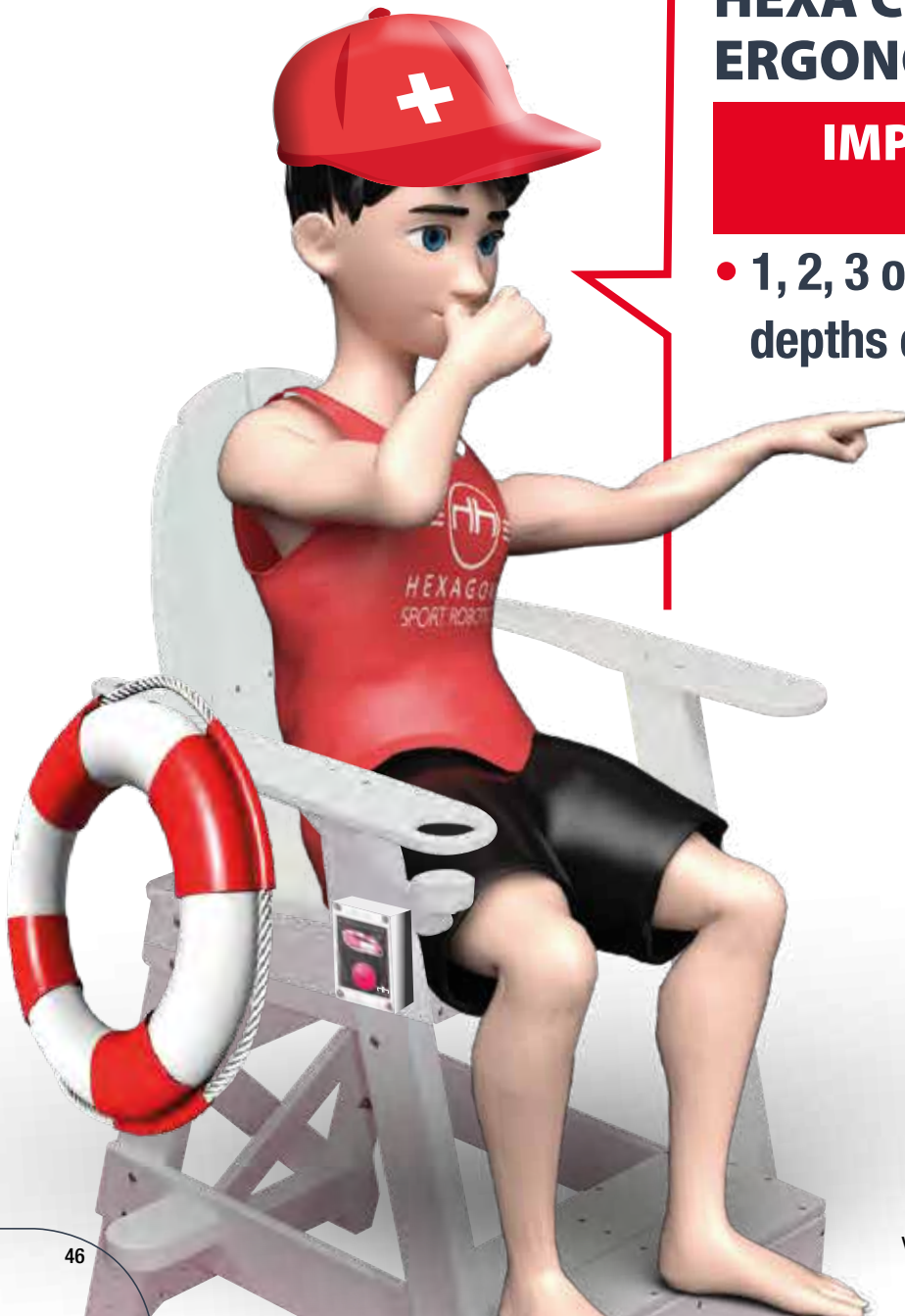

HEXA CHAIR, robust and elegant chair

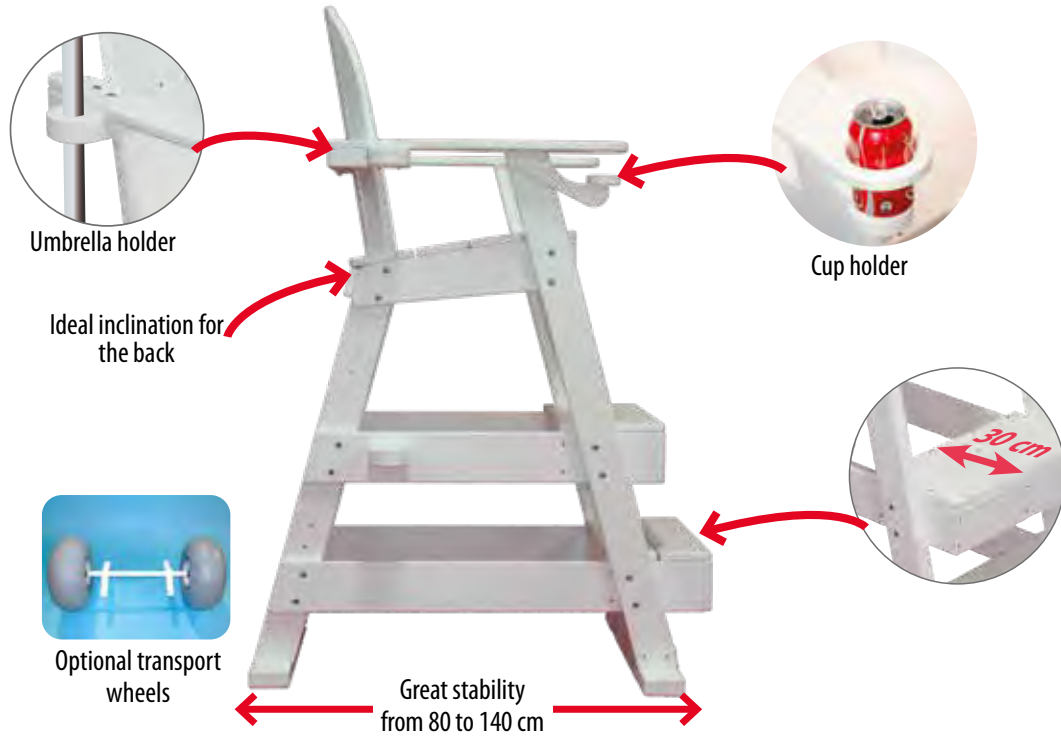

THE PREMIUM AND DESIGN CHAIR



Hexa chair 1 step

Maximum load	Up to 130 kg
Weight	35 kg
Seat height	80 cm
Dimensions (LxDxH)	70 x 80 x 140 cm
Frame/chair	Recycled polypropylene
Reference	z282flg505wh



Hexa chair 3 steps

Maximum load	Up to 130 kg
Weight	70 kg
Seat height	127 cm
Dimensions (LxDxH)	90 x 140 x 180 cm
Frame/chair	Recycled polypropylene
Reference	z282flg515wh



Hexa chair 2 steps

Maximum load	Up to 130 kg
Weight	50 kg
Seat height	100 cm
Dimensions (LxDxH)	80 x 105 x 155 cm
Frame/chair	Recycled polypropylene
Reference	z282flg510wh



Hexa chair 4 steps

Maximum load	Up to 130 kg
Weight	86 kg
Seat height	152 cm
Dimensions (LxDxH)	168 x 125 x 210 cm
Frame/chair	Recycled polypropylene
Reference	z282flg517wh

info@myhexagone.com - 01 34 34 11 55



MNS CHAIRS

OPTIMA HIGH CHAIR



Hexa chair Optima 6 steps

Maximum load	Up to 100 kg
Weight	25 kg
Seat height	190 cm
Dimensions (LxDxH)	76 x 100 x 236 cm
Frame/chair	Aluminium/ PVC
Reference	z446f505

360° PLATFORMS

IDEAL TO WATCH SEVERAL BASINS

- Plastic steps, springboard and seat. Umbrella stand included.
- Large springboard and 90° rotating seat to facilitate vision.



HEXATOUR supervision platform

Maximum load	Up to 100 kg
Weight	60 kg
Seat height	100 cm
Dimensions (LxDxH)	90 x 150 x 166 cm
Frame/chair	Stainless steel/ Plastic
Reference	z218f15674



HEXATOUR supervision platform

Maximum load	Up to 100 kg
Weight	40 kg
Seat height	40 cm
Dimensions (LxDxH)	100 x 150 x 100 cm
Frame/chair	Stainless steel/ Plastic
Reference	z218f15673



Hexa chair platform 3 steps

Maximum load	Up to 180 kg
Weight	70 kg
Seat height	150 cm
Dimensions (LxDxH)	121 x 150 x 177 cm
Frame/chair	Recycled polypropylene
Reference	z093fmlg520w



Hexa chair platform 5 steps

Maximum load	Up to 180 kg
Weight	104 kg
Seat height	183 cm
Dimensions (LxDxH)	150 x 139,7 x 236 cm
Frame/chair	Recycled polypropylene
Reference	z282flg540wh

FIRE FIGHTING HELPO'

IN CASE OF EMERGENCY:

NEW

- 1- Call firefighters in 15 minutes on average
- 2- During this time your Helpo' serves as a shield

Fire protection motor pump via pool water

The average volume of a swimming pool corresponds to 4 to 5 canadairs. A significant quantity that you can count on while waiting for the firefighters. Bring your HELPO' closer to your pool, immerse the suction pipe, deploy the discharge pipe and you are ready in a few minutes to slow the spread of a fire.



Power	7 HP 4T thermal engine
Fuel	Petrol SP95 – E10
Weight	45 kg
Suction height	Up to 7 m
Projection height	Up to 25 m
Total projection capacity	50 m
Pressure/Flow Pressure	7 bar / 16 m³/h
Autonomy	4 hours
Lance (3 positions)	Off / Attack / Defense
Dimensions (LxDxH)	57 x 54 x 75 cm
Reference	NC



**PROTECTION
UP TO 50M
DISTANCE**

ATTACK THROW

SUPERVISION CABIN



Frame on piles

Maximum load	Up to 180 kg
Platform ground height	424 cm
Dimensions (LxDxH)	175 x 350 x 424 cm
Seat height	143 cm
Structure	Made from 100% recycled plastic
Roof	Yes
Reference	NC



**CUSTOM MADE,
CONSULT US**

LIFEGUARD WOODEN STYLE CHAIR



Chaise de sauveteur

Charge maxi	Jusqu'à 150 kg
Hauteur sol plateforme	176 cm
Dimensions (LxPxH)	80 x 59,4 x 176 cm
Hauteur d'assise	132 cm
Structure	En plastique 100% recyclé
Toit	En option
Reference	NC

360° WATCH PLASTIC

- Can be used seated or standing
- Swivel chair with 360° viewing
- Parasol and buoy holder



Malibu Platform

Maximum load	Up to 180 kg
Weight	75 kg
Seat height	150 cm
Dimensions (LxDxH)	137 x 125 x 170 cm
Structure	Recycled polypropylene
Reference	z093flgpf50w

360° WATCH STAINLESS STEEL

- Can be used seated or standing
- Swivel chair with 360° viewing
- Parasol and buoy holder



Plateforme d'observation Friedel

Maximum load	Up to 180 kg
Weight	60 kg
Seat height	150 cm
Dimensions (LxDxH)	120 x 170 x 170 cm
Structure	Stainless steel/ Marine wood
Reference	i00001n001

UMBRELLA



Parasol for MNS

- Special 100% acrylic fabric.
 - ø 180 cm, height 140 cm
 - Aluminum handle ø 40 mm
- Without logo z241f90/10d18011
With Hexagon logo z241h90/10d180-11-n001

RESCUERS

LIFEGUARD CONTROL TOWER

**FOR WATER PARK, BEACH,
CAMPING, MULTI BASINS**

- Protects from the sun and wind
- Designed for outdoor swimming pools
- Design and aesthetics.

**PLATFORMS
CUSTOM
MADE**
(CONSULT US)



HDPE
HDPE plastic
recycling



Evaluate exactly where to stand with this lifeguard print

FLOOR MARKING

Lifeguard position stencil

New standard NF 552-014. Organization and implementation of swimming supervision.

Durable plastic material for long-lasting use. Simply place this lifeguard footprint template where you want it and paint the lifeguard footprint so they know exactly where to stand.

Reference

z282f366877



SIGNAGE

In rigid or adhesive PVC 30 x 30 cm



Mandatory shower
Rigid PVC zs0026n000
Adhesive zs0062n000



Mandatory footbath
Rigid PVC zs0027n000
Adhesive zs0063n000



Do not run
Rigid PVC zs0032n000
Adhesive zs0068n000

- Essential for communicating with your customers about the dangers and obligations.
- Customizable text and signage
- Complies with the new standard NF552-014



Mandatory shower



Never leave your child alone



Do not run



No smoking



Do not eat



Do not dive



Pool depth

1-sided plate 600 x 100 mm
0.30 m
0.60 m
1.30 m
1.70 m
2.50 m

FIRST AID KIT



First aid kit

Aid kit for 10 people delivered filled with infirmary components which provide first aid for communities, water sports workshops and other establishments offering sporting activities.

Reference

NC



Foldable stretcher

PVC stretcher foldable in 4 with its anti-corrosion and anodized aluminum structure. This foldable stretcher in its width and length is without risk of pinching fingers. Its coated PVC canvas is reinforced and washable.

Reference

NC



Semi-automatic defibrillator

Intuitive, efficient, fast and practical for all rescuers! It provides visual and audible operating information to support the rescuer during the intervention.

Reference

NC



Reusable insufflators

Made of transparent silicone and polysulfone. The reusable insufflators are ergonomic and guarantee a long lifespan. They meet not only the needs of the rescuer but also the patient.

Reference

NC



Cervical collars

Available in four adult sizes and two pediatric sizes that cover all patient anatomy. It is used in cases of suspected cervical spine trauma.

Reference

NC



Mucus vacuum cleaner

Manual operation, with a suction power of 450 mmHg. Delivered complete with its 300 ml single-use container, its cap and its two probes (child and adult). Simple squeeze of the trigger creates suction.

Reference

NC

BUOYS/POLE



Buoy wall support

316L stainless steel support.

Reference

qs0124n000



Plastic buoy

In polypropylene.

ø 60 cm 1,3 kg.

z268f5bo010120

ø 73 cm 3,5 kg.

z268fdieaplast



Wall buoy box

Chest alone. Holds a buoy (not included).

ø 60 cm (wall)

z134hsvtcf600mr

ø 75 cm (wall)

z134hsvtcf750mr



Standing buoy box

Chest alone. Holds a buoy (not included).

ø 60 cm.

z134hsvtcf600pt

ø 75 cm

z134hsvtcf750pt



Rescue tube

Foam covered with vinyl.

105 cm long

z506fms031



Rescue tube

Red plastic.

Dimensions: 31,7 x 21,2 cm

z550f8496



Emergency pole

Aluminum ring.

Length 2, 3, 6 m.

Handle with 2 tips

z506fms020.3

NC

MNS RESCUE

GUARANTEE **THE SECURITY** OF YOUR FACILITY

EQUIPMENT COMPLIANT WITH THE LAST STANDARDS

- Rescue and first aid mandatory equipment
- Communication and signaling of safety and security instructions.



SAFETY RELAY, WARNING SYSTEM SPARTEL **WIRELESS** RADIO

TO ALERT THE ENTIRE POOL

- Multizone alert buttons
- Broadcast throughout your entire swimming pool identifiable alert messages
- A receiver to place anywhere, which sounds and displays the area concerned
- Radio wave operation, no wired installation.

This device is only a warning device, it cannot fit into your safety plan.

FABRIQUÉ
EN FRANCE



www.myhexagone.com



BUTTON
ALERT
RADIO IP65

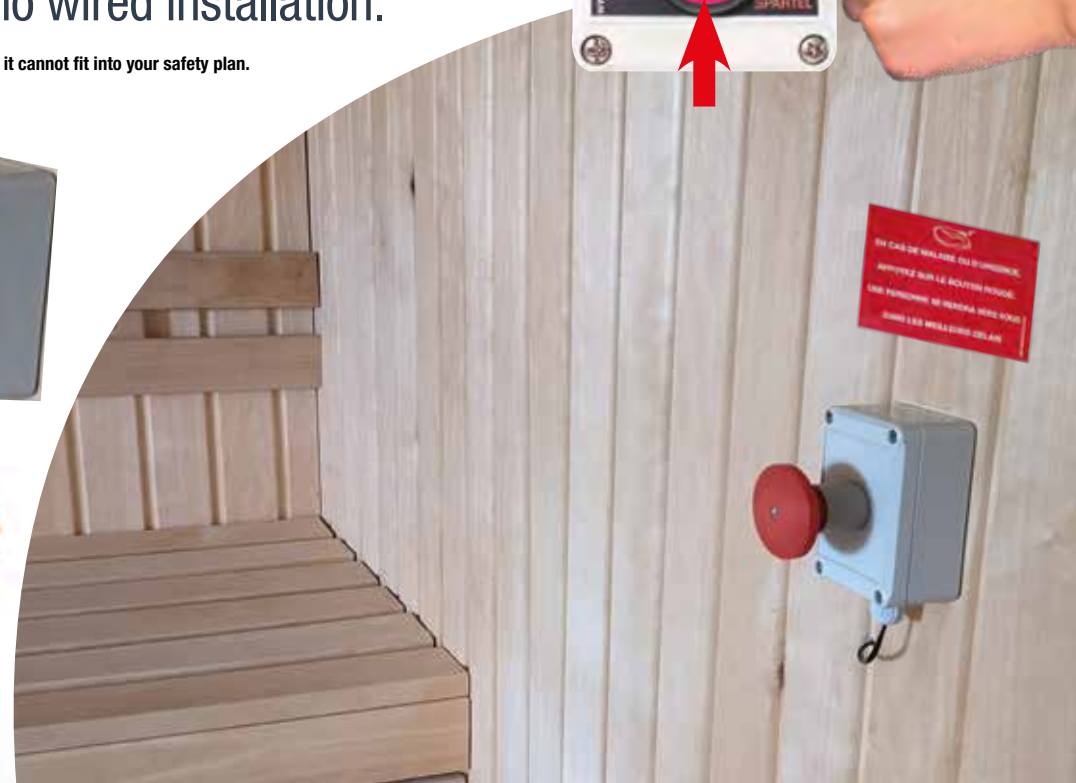

SECURITY ALERT

SAFETY RELAY KIT

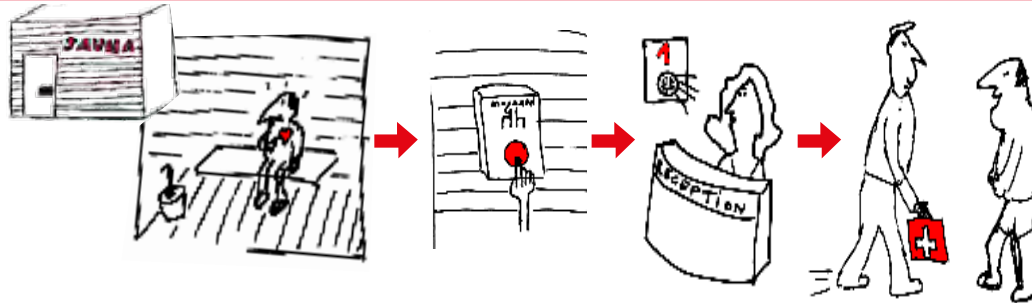

Need assistance? - A panic button - Team alert - We'll arrive immediately...

In the event of a problem in the SAUNA , HAMMAM, at the water's edge, in a changing room, in PRM toilets, put a panic button so that your customers can alert you!

• With adjustment dial from 1 to 9 to choose your zone



Panic button IP65

Power supply 2 1.5 V batteries
Scope 150 m
Waterproof Yes
Dimensions (LxDxH) 100 x 65 x 40 mm

Reference egs002n003



IP68 multi-zone radio control

Power supply 2 1.5 V batteries
Scope 150 m
Dimensions (LxDxH) 118 x 68 x 37 mm

Reference egs001n001



Sauna panic button IP65

Power supply 2 1.5 V batteries
Scope 150 m
Dimensions (LxDxH) 100 x 65 x 40 mm

Interior button egs004n000
Exterior button egs005n002



Central receiver/led diffuser and IP65 speaker

Power supply 220 V socket
Scope 150 m
Waterproof Yes
Optional power supply Solar panels
Dimensions (LxDxH) 254 x 180 x 90 mm
Reference egs003n000



Panic button with announcement IP65

Power supply 2 1.5 V batteries
Scope 150 m
Dimensions (LxDxH) 100 x 65 x 40 mm

Reference egs003n003

OPTIONAL

IP66 radio signal repeater

Power supply Prise 220 V
Scope 100 m
Dimensions (LxDxH) 180 x 94 x 60 mm



Reference egs005n000 (single)
Reference egs006n000 (wall)

info@myhexagone.com - 01 34 34 11 55

SHOWER ALARM

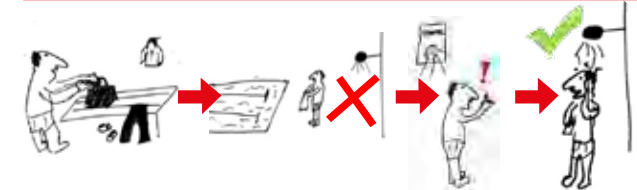

Take a shower, I don't care - Automatic reminder system
- Ok, I'll take the shower...

Unique automatic reminder system for the **MANDATORY** passage TO THE SOAPY SHOWER!

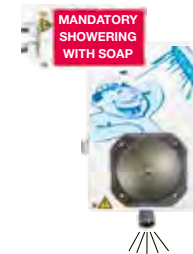

SPARTEL shower alarm

MANDATORY SOAPED SHOWER
Case width 20 cm. Height 30 cm.
220W/24V DC. 70 db speaker. IP66.
Infrared sensor.
Automatic and customizable recorded message.
Detector up to 5m.
Reference egs004n000

COMMUNICATION



Megaphone

Megaphone + siren. Supplied without batteries. Large range up to 450 m.

Reference z569f7566

Whistle

Plastic ball whistle. Reference z354f93741

Bell

Bell with fixed molding. Reference z456f21.530.00



Motorola T62 walkie talkie

Connected while traveling with a range of up to **8 km (depending on terrain)**.
Licensed device with an LCD screen, 16 channels.
Dimensions : 5.4 x 16.5 x 3.1 cm

Red Reference z701fmot62r
Blue Reference z701fmot62b

DISPLAYS/STOPWATCHERS



Digital temperature display

Display of pool temperatures: air, water and time.
 220/24V DC. Dimensions : 130 x 32 x 9 cm.

Reference

z437fph12.1



Digital display

Digital LED display, pool temperatures: air, water and time.
 Dimensions : 46 x 32 x 9 cm.

Reference

z437fph9.2



Wall stopwatch

4 needles. Dimensions : 62,5x62,5x10 cm.
 Power consumption 10 W. 220 Volt
 Designed for use at temperatures from 10 to 35°.

Reference

z506fe539

TRAINING EQUIPMENT



Senior Boy Sweater

Dimensions : 23 x 8 x 13 cm. Made in Golfoam.
 Available in various colors.

Reference

z506ft406



Pair of Pad

Small : 17,5 x 11 cm. Reference z506ft411
 Medium : 18,5 x 11,5 cm. Reference z506ft408
 Large : 19,5 x 13 cm. Reference z506ft407



Pair of fins

Made of high quality pure rubber.
 Ideal for swimming.
 Sizes from 26 to 48 cm (contact us).

Reference

NC

SCHOOL IDEAL

SEPARATION LANE



With floats and transparent tube

Polypropylene float 80 x 50 mm.
 Colors: blue, white, orange, red, yellow green.
 Sold by the meter equipped with 4 to 6 floats.
 Available on polyethylene rope or stainless steel cable.

Reference

NC



With polyethylene floats

2 lengths 25 and 50m or sold by the meter.
 Polypropylene float 80 x 50 mm.
 Colors: blue, white, orange, red, yellow green.

Available on polyethylene rope or stainless steel cable.

Reference

NC



SWIM LANE REELS



150 cm

Reel L.150 or 200 cm

Designed to wind lines. In electro-polished stainless steel.
 Equipped with 4 wheels, 2 of which have brakes.

L.150 cm. Reference z506fe5258.150+ z506fe5259.150
 L.200 cm. Reference z506fe5258.200+ z506fe5259.200

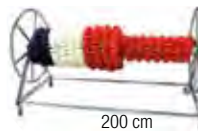

200 cm

	Competition	Moscow	Rome
150 cm	50 m	100 m	200 m
200 cm	75 m	150 m	300 m



Lane distributor

Ideal for the edge of pools and swimming line floats.

Reference

z197f10111021

STARTING BLOCKS



Starting block

In AISI-316 stainless steel, electropolished.
 Antislip FV platform. Rear opening system to place the electronic sync speaker inside. Numbering on 4 sides.
 Compatible with the false start detection system.

Platform 74 x 52 x ht 40 cm Reference z506fe5204

**ADJUSTABLE SUPPORT
 IN 5 DIFFERENT POSITIONS**

LINE POSTS



Turning line

Four 2 meter high posts in AISI-316 stainless steel.
 Equipped with rings to secure the line.
 Turn line composed of nylon rope and flags
 Available in 12,5m, 17m, 21m, 25m.

Poles Reference
 Pennant Reference

NC
 NC

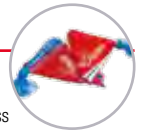

False start line

Two 2 meter high posts in AISI-316 stainless steel
 Equipped on a post with a ring to fix the line and on the other post of a pulley to tighten and tie the line.
 False start line composed of a nylon rope and Roma type floats.
 Available in 12m, 17m, 21m, 25m

Poles Reference
 Float Reference

NC
 NC

FASTENERS



Nylon rope - 6 mm
 Sold by the meter

z506fe5200



Hook ø 8mm stainless steel
 AISI-316

z506fe5231



Carabiner - 60mm or 80mm stainless steel
 AISI-316 z506fe511

z506fe5215



Swim lane stabilizer 50 m stainless steel
 AISI-316d

z506fe514



AISI-316 stainless steel tensioner

z506fe5233



AISI-316 stainless steel ratchet tensioner
 Includes a hook

z506fe5202

ANCHORS



Anchor for rectangular swimming line stainless steel
 AISI-316

z506fe516



Anchor for round swimming line stainless steel
 AISI-316

z506fe5028



Post to assemble with tubular anchor stainless steel
 AISI-316

z506fe552



Tubular anchor in AISI-316 stainless steel. Diameter 43 mm or 46 mm.
 Straight or inclined

NC

SWIM LANE

TRAINING

Ø 100



HEXA STAR 100 swim lane

Disc diameter ø 100 mm
Line length 25 and 50 m
25 m Reference z506fe5239.25ss
50 m Reference z506fe5239.50ss
With cable, tensioner and stabilizer in AISI-316 stainless steel.

COMPETITION

Ø 150



HEXA STAR 150 swim lane

Disc diameter ø 150 mm
Line length 25 and 50 m
25 m Reference z506fe5011
50 m Reference z506fe5012
With cable, hook and stabilizer in AISI-316 stainless steel.

HIGH-RESISTANCE SWIM LANE, COMPLIANT WITH «FINA» STANDARDS SPORT COMPETITION SWIM LANE

- 5 colors: blue, red, green, white and yellow
- Mounted on AISI316 stainless steel wire ø 4 mm
- High resistance to chemical & UV agents

**Simple and practical
installation!**



Ø 100



Ø 150

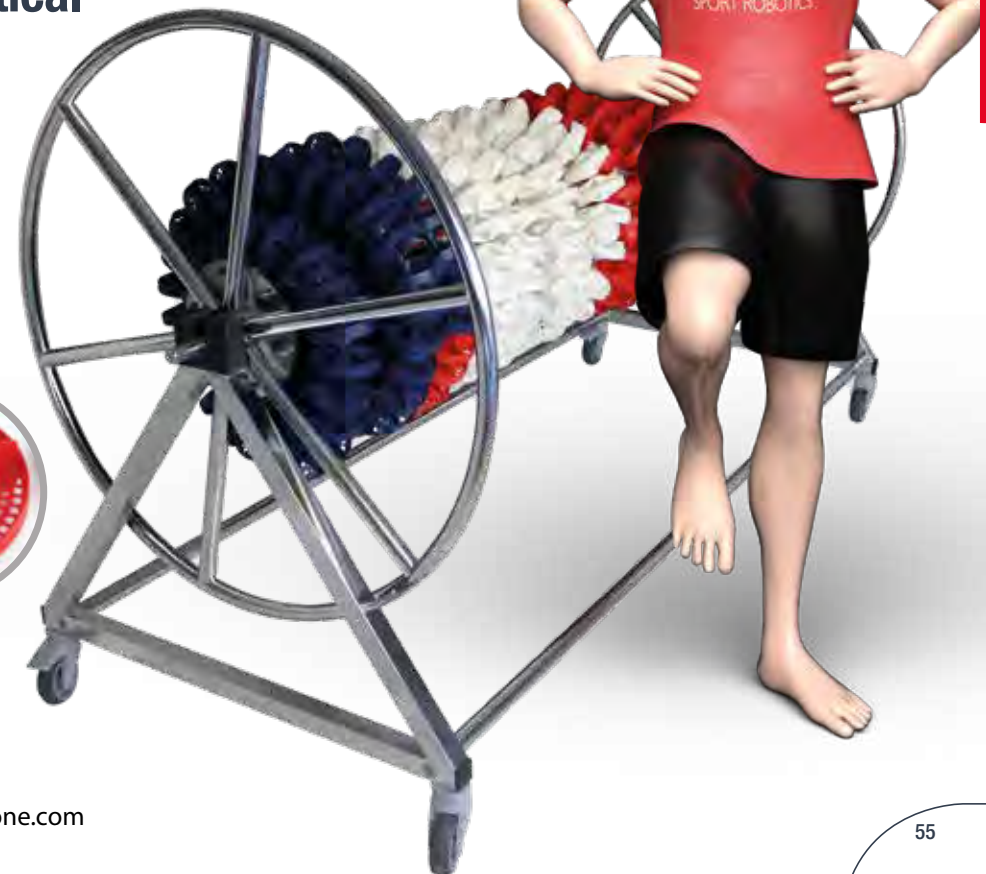

STERI-KLEEN



Ozonated water outlet ▶
◀ Water network inlet

Filling
(accessory
included)

Sterilizes your pedagogic equipment

Power plant for creating stabilized aqueous ozone to clean and disinfect without chemicals.

- No residue on surfaces
- Without PPE, food approved

Power supply 100-240V/50-60Hz
Duration of action 60 mins in the open air
3 hours in a container
Ozone concentration 0,5-1.0mg/l
Production capacity 900 000 liters
Water flow 2,5l/min-6l/min
Dimensions (L x D x H) 27,7 x 8,9 x 36,7cm
Weight 1,9 kg
Reference z549fwpoz1.0-e



TRASH BIN



Arnold & Wily trash can

Rotomolded polyethylene.
Arnold: Capacity 70 liters. Height 90 cm. Width 74 cm.
Reference z134hpbblurain
Wily: Capacity 70 liters. Height 120 cm. Width 75 cm.
Reference z134hpbbludaup

BARRIERS

Plastic barriers

Unbreakable. Weight 9.2 kg. 100% recyclable.
Lightweight and easy to move. Dimensions:
198 x 55.5 x 102 cm. Available in 5 variegated
colors. White, yellow, red, green, blue.
Reference z304furban2000



PVC BENCHES



Bench L.100/200 cm

Dimensions (D x H): 40 x 50 cm. White, beige and gray colors.
L.100 cm Reference z506fe590
L.200 cm Reference z506fe591



Bench with backrest

Dimensions (D x H): 40 x 77 cm. White, beige and gray colors.
L.100 cm Reference z506fe513.1
L.150 cm Reference z506fe513.15
L.200 cm Reference z506fe513.2



Single and double locker room

Dimensions (D x H): 56 x 185 cm. White, beige and gray colors.
L.100 cm Reference z506fe510.1
L.150 cm Reference z506fe510.15
L.200 cm Reference z506fe510.2

Dimensions (D x H): 88 x 185 cm. Coloris blanc, beige et gris.
L.100 cm Reference z506fe507.1
L.150 cm Reference z506fe507.15
L.200 cm Reference z506fe507.2

PVC SHELVES



PVC shelves

Dimensions (D x H): 40 or 50 x 195 cm.
White, beige and gray colors.
L.100 cm Reference z506fe5004.1
L.150 cm Reference z506fe5004.15
L.200 cm Reference z506fe5004.2



Shelf on casters

Dimensions (D x H): 60 x 195 cm.
Coloris blanc, beige et gris.
L.140 cm Reference z506fe5160



Basket for fries

Dimensions (D x H): 46 x 85 cm.
Coloris blanc, beige et gris.
L.66,5 cm Reference NC
Base only Reference NC

PVC STORAGE TROLLEYS/BINS



Cart/Storage bin

Dimensions (D x H): 87 x 80 cm. White, beige and gray colors.
L.200 cm Reference z506fe558



Cart/Storage bin with lid

Dimensions (D x H): 87 x 80 cm. White, beige and gray colors.
L.200 cm Reference z506fe558t



Trolley/Bin for fins

Solid structure. Resistant to humidity, acids and grease.
6 casters including 3 with brakes.
Dimensions (D x H) : 80 x 115 cm.
White, beige and gray colors.

L.150 cm Reference z506fe5170



Trolley/Noodles tray

Dimensions (D x H): 50 x 130 cm. White, beige and gray colors.

L.100 cm Reference z506fe5092



Cart/Carpet storage bin

Dimensions (D x H): 80 x 150 cm. White, beige and gray colors.

L.220 cm Reference z506fe5221



Cart/Dumbbell tray

Dimensions (D x H) : 40 x 125 cm. CWhite, beige and gray colors.

L.140 cm Reference z506fe5155

POOL FURNITURE

SPECIAL STORAGE FOR COLLECTIVE POOL

CHLORINE-RESISTANT PLASTIC FURNITURE

- Optimal and suitable storage
- Better longevity of your equipment
- Stainess steel wheels.



3 colors available
(dark gray, light gray, beige).
Other colors, contact us.



www.myhexagone.com

THE SUN GIVES A PERFECT MATCH

BETWEEN THE UMBRELLAS AND SUN BATHS

- Many colors available
- Resistant to salt and other weather conditions
- A unique and durable Italian design.



CUSTOM MADE,
LARGE CHOICE OF COLORS

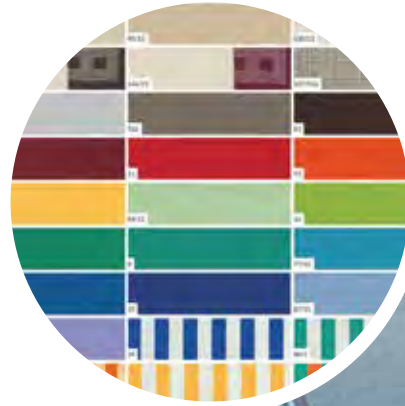

POOL FURNITURE

UMBRELLAS



- UV resistant
- 100% acrylic 290 gr/m²
- Large choice of colors



Matisse

Diameter: 200, 220 or 240 cm, height 160 cm.
Anodized aluminum pole 20 microns Ø 4 cm
Weight: 5 to 5.70 kg

Reference

NC



Miro

Diameter: 180, 200, 220, 240 or 260 cm, height 140 cm.
Anodized aluminum pole 20 microns Ø 4 cm
Weight: 4.30 to 5.90 kg

Reference

NC



Mondrian

190 x 190 or 200 x 200 cm, height 150 cm.
Anodized aluminum pole 20 microns Ø 4 cm
Weight: 7.3 to 7.8 kg

Reference

NC



Picasso

200 x 200 or 250 x 250 cm, height 165 or 85 cm.
Anodized aluminum pole 20 microns Ø 4.5 cm
Weight: 4.80 to 5.10 kg

Reference

NC

ALUMINUM LOUNGE CHAIRS



- Great value for money
- Large choice of colors



First class aluminum/canopy XL

20 cm more for the legs. Backrest adjustable in 3 positions.
Canvas and sunshades in polyester covered with PVC, with the possibility of inserting heat-sealed inscriptions.
Dimensions (l x D x H): 204 x 84 x 40 cm.
Reference

NC



Comfort+ aluminum/canopy

Backrest adjustable in 3 positions.
Canvas and sunshades in polyester covered with PVC, with the possibility of inserting heat-sealed inscriptions.
Dimensions (l x D x H): 182 x 73 x 40 cm.
Reference

NC



Aluminum comfort

Backrest adjustable in 3 positions.
Canvas and sunshades in polyester covered with PVC, with the possibility of inserting heat-sealed inscriptions.
Dimensions (l x D x H): 194 x 73 x 40 cm.

Reference

NC



Basic canvas sunbed

Backrest adjustable in 4 positions. Stackable.
Canvas and sunshades in polyester covered with PVC, with the possibility of inserting heat-sealed inscriptions.
Dimensions (l x D x H): 208 x 62 x 40 cm.
Reference

NC

PLASTIC LOUNGE CHAIRS



- UV resistant
- Antibacterial treatment
- Stackable
- Anti-slip feet



Adjustable canvas

The upper part of the deckchairs is mobile and has 5 possible heights depending on the desired position.
The deck chairs are made of polypropylene resin.
Dimensions: 194 x 76 x 57 cm. Lying height approx. 37 cm.
Large choice of canvas colors (to be specified).
Reference

NC



Chassis available in 3 colors



Adjustable slatted

5 positions.
Dimensions: 194 x 77 x 57 cm.
10 color choices to be specified.

Reference

NC



Fixed slatted

Fixe.
Dimensions: 194 x 76 x 49 cm.
10 color choices.

Reference

NC



Fixed canvas

Fixed canvas.
Dimensions: 194 x 77 x 57 cm.
Lying height: 37 cm.
Large choice of canvas colors (to be specified).
Reference

NC



Chassis available in 8 colors

AQUA SPORT COURSE



HEXA ORBITAL



HEXA BIKE ONE 100



HEXA BIKE ONE 200



HEXA TREKK 100



HEXA RUN PREMIUM



HEXA JUMP 100

TECHNICAL DATA

Maximum load
Weight
Material
Depth of use
Dimensions (LxDxH)
Suction cup
Casters
Brakes
Colors
Page number

120 kg
18,3 kg
316L stainless steel
110-150 cm
99 x 72 x 145 cm
4
4 at the front
Without
—
66

120 kg
15,2 kg
316L stainless steel
110-150 cm
84 x 60,4 x 120 cm
4
2 at the front
Without
—
66

120 kg
18,3 kg
316L stainless steel
110-150 cm
127 x 60,4 x 101 cm
4
2 at the front
Without
—
66

120 kg
15,2 kg
316L stainless steel
110 - 150 cm
127 x 60,4 x 101 cm
4
2 at the rear
Without
—
66

—
35 kg
316L stainless steel
120-140 cm
127 x 65 x 139 cm
6
2
Without
—
66

—
13 kg
316L stainless steel
100-140 cm
120 x 106 x 33 cm
6
—
Without
—
66

AQUAGYM BUTTERFLY - SONO



FINS/ BRACELETS



HEXA SONO M or XL



SWIMSUIT DRYER



PREMIUM HAIR DRYER



OPTIMA HAIR DRYER



EPHEMERALCOLORING

TECHNICAL DATA

Dimensions (LxDxH)
Material
Page number

20 x 12 x 21 cm/ ø23 x P.16 cm
ABS marine quality
68

H.56,8 to 68,8 cm
—
70

37,5 x 36,5 x 59 cm
Polyethylene
62

25 x 38 x 121 cm (stem)
—
63

15 x 41 x 115 cm
—
63

—
—
64

You are not decided, you want one

COMFORT AND WELCOME FOR YOUR CUSTOMERS

AQUA FITNESS HEALTH



TECHNICAL DATA

Maximum load
Weight
Material
Depth of use
Dimensions (LxDxH)
Suction cup
Casters
Brakes
Colors
Page number

HEXA BIKE Optima 100

120 kg
12 kg
Polyethylene/stainless steel
120-140 cm
115 x 92 x 66 cm
8
Without
Without
3*
68

HEXA BIKE Optima 200

120 kg
16 kg
Polyethylene/stainless steel
120-170 cm
120 x 160 x 66 cm
9
Without
With
3*
68

HEXA RUN

—
25 kg
Polyethylene/stainless steel
120-140 cm
135 x 82 x 153 cm (unfolded)
8
4 at the front
Without
3*
68

HEXA JUMP DESIGN

—
9 kg
Polyethylene/stainless steel
80-170 cm
ø106 cm - H.22 cm
8
Without
Without
3*
68

HEXA MULTI EXERCICE

—
20 kg
Polyethylene/stainless steel
160-180 cm
ø98 cm - H.170 cm
10
Without
Without
2
68

HEXA STEP

—
7 kg
Polyethylene
110-130 cm
67 x 35 x 19 cm
8 suction cup
Without
Without
1 color
68

* Royal blue, Orange, Green as standard - for other colors minimum quantity of order of 6 units and 12 weeks lead time.

BABY SWIMMERS



TECHNICAL DATA

Dimensions (LxdxH)
Material
Page number

HEXA BABY CHAIR

60 x 50 x 76 cm
Polypropylene
72

CHANGING TABLE

100 x 65 x 95 cm
Pvc
72

FLOATING MAT

Consult us
Golfoam
73

AQUATIC CAGE

200 x 200 x 200 cm
Aluminum tube
73

NOODLES

Consult us
Golfoam
73

BOARDS

Medium, large, eurokick
Retifoam
73

other product, do not hesitate to contact us...



SWIMSUIT DRYER, YOUR CUSTOMERS WILL LOVE IT!

EXTRACT 95% OF THE WATER FROM THE SWIMSUIT IN 8"

- An additional service for your customers
- Prevents your customers from leaving with a wet bag
- Adapted to any environment
- Easy to use in complete safety

Quick installation!

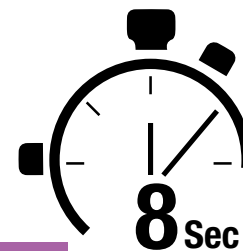

For exceptional service, after the pleasure of bathing...

5 steps:



1- lift the lid



2- insert the wet swimsuit



3- close the lid

8 seconde spin



4- lift the lid



5- take back the swimsuit wrung out to 99%



Translucent luminous version (OPTIONAL)

Simple 220V connection, with water drain or recovery tray (not supplied)



Tank

DRY 'N' GO

- Wide range of colors
- End of cycle timer
- Possibility of including a coin mechanism (optional)



DRY 'N' GO motorisé

Power supply	240V 50 / 60Hz, 3600 tr/mn
Weight	20 kg
Structure	Polyethylene
Dimensions (LxDxH)	37,5 x 36,5 x 59 cm
Colors	9 (contact us)
Reference	z184hssd



Aesthetics and Design in 9 colors

info@myhexagone.com - 01 34 34 11 55

CLOAKROOMS

ANTI-VANDALISM HAIR DRYER

- Robust hot air shower, for intensive use
- Radar with 2.5 min timer, automatic triggering
- Fixed or adjustable on 1.20m rail
- With 90 cm mirror (rail version)



Hexa Rez

Power	2000W, 70°C	
Sound level	70 dB	
Fixed dimensions (LxDxH)	24,5 x 30 x 30,5 cm	
Stem dimensions (LxDxH)	25 x 38 x 121 cm	
Colors	11 (contact us)	
Fixed	Reference	z569f1600ral
Rail	Reference	z569f1602ral
Rail+Mirror	Reference	z569f1601ral



Also available in ABS aluminum color RAL 9006 and anthracite gray RAL 7016

OPTIMA HAIR DRYER



Neptune with adjustable height

Power	2000W
Sound level	70 dB
Dimensions (LxDxH)	15 x 41 x 115 cm
Colors	3
Reference	z466f82214



Wall with flexible

Power	900W
Sound level	72 dB.
Dimensions ((LxDxH)	32,2 x 18,2 x 50 cm
Colors	White
Reference	z661ftb-c1



Wall-Anti-vandalism

Power	2100W
Sound level	70 dB
Dimensions (LxDxH)	25,5 x 14 x 28 cm
Colors	White
Reference	z466f822009

SPA / SAUNA PERFUME

Discover our relaxing, energizing, refreshing, stress-relieving, slimming, invigorating or positive fragrances.

Fragrances based on 100% pure and natural essential oils for spa. The product is completely volatile so as not to leave traces in the filter cartridge.



Spa perfume

Lavender

Relaxing
1L
z145fspla100
5L
z145fspla500



Eucalyptus

Respiratory
1L
z145fspeu100
5L
z145fspeu500



Cedar

Stimulates
conviviality
1L
z145fspcl100
5L
z145fspcl500



Luxury

Energizing
1L
z145fsplu100
5L
z145fsplu500



Lemon

Stimulating
1L
z145fspcc100
5L
z145fspcc500



Sauna perfume

Luxury

Energizing
1L
z145fsalu100
5L
z145fsalu500



Eucalyptus

mint
Refreshing
1L
z145fsaem100
5L
z145fsaem500



Eucalyptus

Respiratory
1L
z145fsaeu100
5L
z145fsaeu500



Polynesia

Regenerating
1L
z145fsapo100
5L
z145fsapo500



Orange

Blossom
De-stressing
1L
z145fsafo100
5L
z145fsafo500

PRO INFLATABLE SPA



Spa Exotic Pro 4

CE – ISO9001 certified

• Ideal and lightweight for installation and removal on mobile home terraces.

• Super resistant membrane.



Number of places	4
Int./ext. diameters	1,40/1,80 x 0,70m
Air jet	118
Water volume	700 L
Weight	34,5 kg
Reference	Z514FA082207

SAUNA EQUIPMENT



Sauna thermometer

Sauna hygro-thermometer.

Reference

z218fsas92300



Wooden bucket

Wooden sauna bucket.
4 liters.

Reference

z218fsac10003

Wooden ladle

Wooden sauna ladle.
36 cm.

Reference

z218fsac10640



Wooden hourglass

Sauna hourglass.
15 minutes.

Reference

z218fsac19900

Sauna stone

Rock in a 20 kg bag.

Reference

z370fac3000



Sauna lamp

40W sauna lamp.
Delivered without bulb.
Suitable for all saunas.

Reference

z218fsas21060t



Wooden headrest

Wooden sauna pillow.

Reference

z218f34011



EPHEMERAL COLOURING



NEW

AquaCouleur swimming pool and Spa

Allows you to temporarily color spas, fountains and ponds. Without any harmful effects for bathers, without any persistent coloring visible on clothing, without any irritation to the eyes and without any possibility of poisoning by ingestion. Dermatologically tested. Our bottles range from 30ml to 10 liters to be diluted in the skimmer or filtration basin. Effectively colors a volume of water from 1 to 3,000 m³. Colors from 6 hours to 3 days maximum.

3 colors to choose from:
Conditioning :

Lagon, Fuchsia, Lavender
Spa box (3 bottles of 30ml) ou 1L, 5L ou 10L NC

EPHEMERAL PERFUME

AquaParfum swimming pool

A unique olfactory experience for your customers!

For swimming pool, spa, sauna, hammam. Made from 100% perfumes and no water, alcohol or essential oils. Soothing, energizing atmospheres that invite you to travel... Cosmetic quality. Health safety validated. Made in France. No skin risk
• ISO 9001 & 22716.
12 fragrances to choose from: Bubble gum, Coco, Douceur, Eleganc, Cherry Blossom, Orange Blossom, Litchee, Manzana, Leather and Musk, Peony Gourmande, Romance, Volupté.



NEW

Individually or Box of 3 x 3 scents.
Reference

NC

HEXA COLOR EPHEMERAL, TO CREATE A UNIQUE ANIMATION

BRING COLOR TO YOUR EVENTS!

- Red for a «Halloween» evening
- Purple for a «Zen» moment
- Lagoon blue for a «change of scenery»,
and add a room fragrance to go with it...



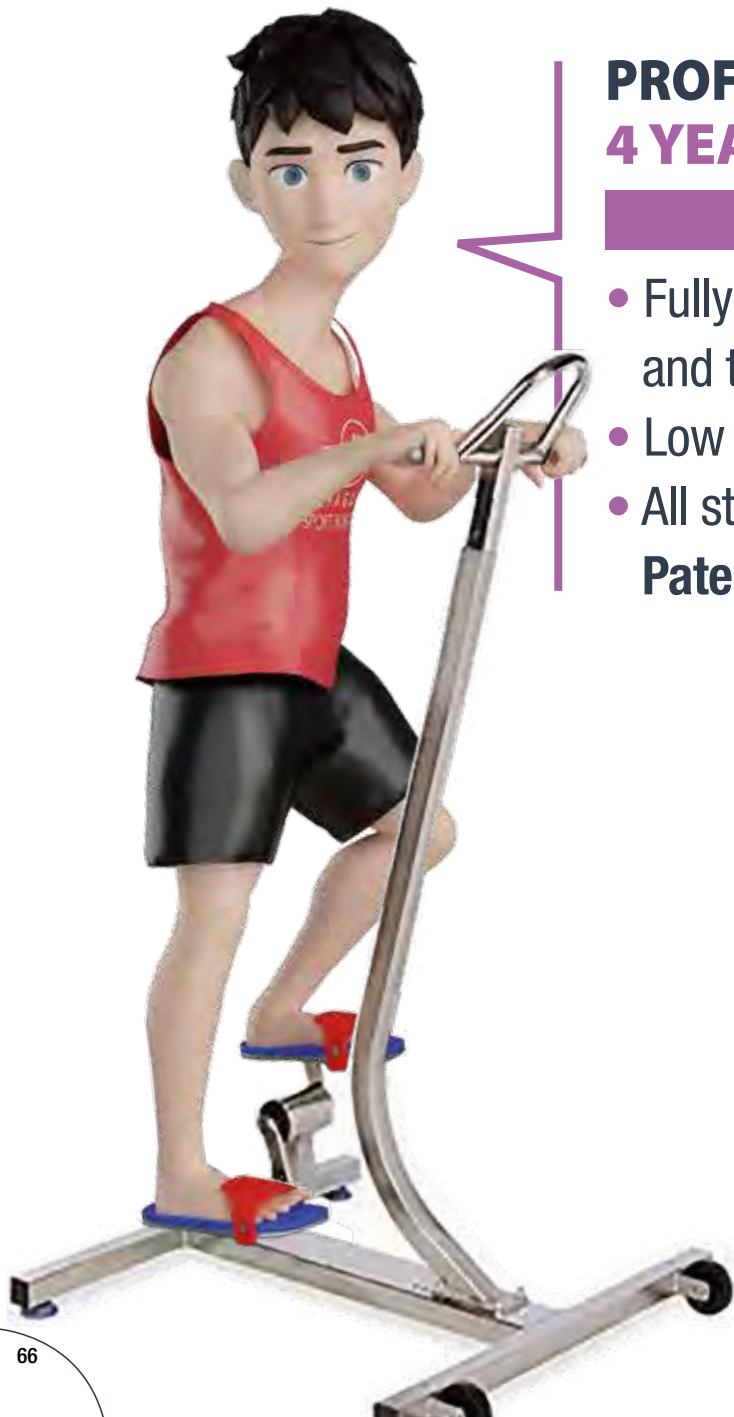

PROFESSIONAL AQUAFITNESS EQUIPMENT 4 YEAR WARRANTY

STAINLESS STEEL SPORT RANGE

- Fully adjustable depending on the depth of water and the size of the user
 - Low maintenance
 - All stainless steel - 316L
- Patented pedal with progressive resistance.**



**Pédale testée
biologiquement**
Class VI 6.6.1 ISO
10993-5/10/11
Fabriquée en France

Stainless steel structure



HEXA BIKE INOX, long live aquatic fitness!



BIKE INOX SPORT



Hexa Bike One 100

Weight	15,2 kg
Maximum load	120 kg
Material	Stainless steel 316 L
Depth of use	110 - 150 cm
Dimensions	84 x 60,4 x 120 cm
Suction cups	4
Casters	2 at the front
Reference	z247f0492-006



Hexa Bike One 200

Weight	18,3 kg
Maximum load	120 kg
Material	Stainless steel 316 L
Depth of use	110 - 150 cm
Dimensions	127 x 60,4 x 101 cm
Suction cups	4
Casters	2 at the front
Reference	z247f0492-001

TREKK/JUMP INOX SPORT



Hexa Trekk 100

Weight	15,2 kg
Maximum load	120 kg
Material	Stainless steel 316 L
Depth of use	110 - 150 cm
Dimensions	127 x 60,4 x 101 cm
Suction cups	4
Casters	2 at the rear
Reference	z247f0492-011



Hexa Jump 100

Weight	13 kg
Material	Stainless steel 316 L
Depth of use	100 - 140 cm
Dimensions	120 x 106 x H.33 cm
Support bar dimensions	110 à 138 cm (adjustable)
Suction cups	6
Reference	z247f0492-020

info@myhexagone.com - 01 34 34 11 55

AQUA COURSE

HEXA ORBITAL



NOVELTY



Hexa Orbital

Weight	28,4 kg
Maximum load	120 kg
Material	Stainless steel 316 L
Depth of use	110 - 150 cm
Dimensions	99 x 72 x 145 cm
Suction cups	4
Casters	2 at the front
Reference	z247f0492-002

REHABILITATION SPECIAL



Hexa run Premium

Weight	35 kg
Material	Stainless steel 316 L
Depth of use	120 - 140 cm
Dimensions	127 x 65 x 139 cm
Suction cups	6
Casters	2
Brakes	Without
Reference	z247f0492-005

AQUA GYM HEALTH KIT



BUTTERFLY SUPPORT KIT

Marine quality ABS material.
Pink or blue color.
Depth of use not limited.

Fins
380 gr
L.20 x P.12 x H.21 cm
2 fins

Bracelets
440 gr
ø 23 - P.16 cm
2 bracelets



BUTTERFLY PROGRAM SHEETS

AQUA REHABILITATION PROGRAM:

- back pain
- after breast cancer
- prenatal/ post-natal
- heavy legs (circulation)
- sporting gesture (tennis, golf, etc.)
- upper and lower body



IDEAL PROGRAM
PRENATAL



REHABILITATION AFTER
BREAST CANCER



REINFORCEMENT
BACK POSTURE

Alliance between aesthetics and performance

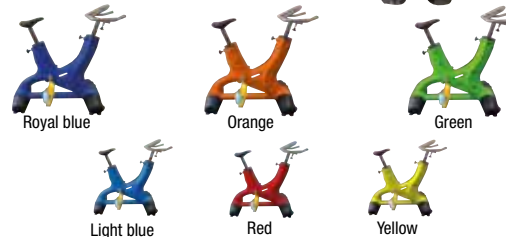
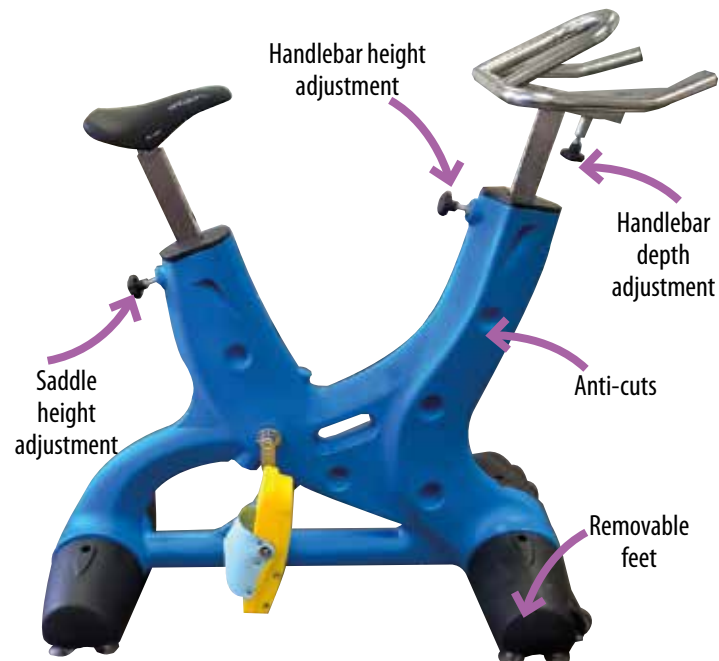

* Royal blue, Orange, Green as standard - for other colors minimum quantity of order of 6 units and 12 weeks lead time.

HEXA BIKE COLOR



Hexa Bike Optima 100

Maximum load	120 kg
Weight	12kg
Material	Polyethylene/stainless steel
Depth of use	120-140 cm
Dimensions (LxDxH)	115 x 92 x 66 cm
Suction cups	8
Brakes	Without
Reference	3 colors



Hexa Bike Optima 200

Maximum load	120 kg
Weight	16 kg
Material	Polyethylene/stainless steel
Depth of use	120-170 cm
Dimensions (LxDxH)	120 x 160 x 66 cm
Suction cups	9
Brakes	With
Reference	3 colors

ACCESSORIES



Comfort saddle
Cushioned saddle, height adjustable
z645h0003



Suction cup
Semi-rigid transparent suction cup with integrated stainless steel screw.
z645h0004



Pedal with strap
Ergonomic shape. Ideal for all sizes.
z645h0030n000

RUN / JUMP / POLE / STEP



Hexa run

25 kg
Polyethylene/stainless steel
120-140 cm
135 x 82 x 153 cm (unfolded)
8 suction cup
4 casters at the front
3 colors



Hexa jump Design

9 kg
Polyethylene/stainless steel
80-170 cm
ø 106 cm H. 22 cm
8 suction cup
3 colors



Hexa multi exercise

20 kg
Polyethylene/stainless steel
160-180 cm
ø 98 cm H. 170 cm
10 suction cup
Without casters
1 color



Hexa step

7 kg
Polyethylene
110-130 cm
67 x 35 x 19 cm
8 suction cup
1 color

AQUA SHAPE DESIGN

IDEAL FOR FITNESS SPACES WHO NEED DESIGN

ELEGANT AQUAFITNESS

- Multi colors, attractive design
 - Adjustable posture adjustment
 - Increased stability with its specific suction cups
- Special barefoot pedal!**



BIKE



RUN



JUMP



HEXA MULTI EXERCISE

www.myhexagone.com



EASY USE TRANSPORT HANDLE



SPECIAL AQUAFITNESS SOUND RESISTANT IN AQUATIC ENVIRONMENTS

OPTIMAL SOUND TO LIVE YOUR SESSIONS

- A SOUND THAT MAKES your customers move
- Long-lasting lithium battery
- Sound system in suitcase mode, easy to transport

Reference brand: JBL



HEXA SONO

NEW



Hexa sono M

Weight	11 kg
Power	160W
Connection	Bluetooth, range 10m
Dimensions	29,5 x 56,8 x 30 cm
Autonomy	12 hours
Battery	lithium-ion 72 W
Loading time	3,5 hours
Reference	z820fjblpartybox110eu

Hexa sono XL à roulettes

Weight	17,4 kg
Power	240W
Connection	Bluetooth, range 10m
Dimensions	32,6 x 68,8 x 36,8 cm
Autonomy	18 hours
Battery	lithium-ion 72 W
Loading time	3,5 hours
Reference	z150f70782



Transport handle and wheels



UNDERWATER SPEAKER



IDEAL FOR SYNCHRONIZED SWIMMING

Underwater speaker

Syncho Swim Sound is a built-in underwater speaker on the benefits of water through sport speaker. Designed to be installed in the most common PAR 56 underwater spotlight niches. 50 Watts RMS on 8 Ohm. 100 peak watts. Insulation class: IP69. Resistant to diving up to 3 meters. Weight: 2.5 Kg. Plastic, stainless steel. White colour.

Reference

z465f



CUSTOMIZED AQUAFITNESS TRAINING!



3 reasons to organize aquafitness classes with Hexagone:

1- Our qualified instructor

Simon Rives :

Your Butterfly, Aqua bike, Aqua Jump and Aqua fitness instructor!

- former polo player
- student in STAPS and BE
- a pronounced taste for carrying out choreographed lessons



2- Our educational approach

- Analysis of your working conditions
- Program adapted to your needs and according to your abilities
- On-site courses with experienced professionals (up to 15 people)
- Consultations and support by telephone or video conference during the 2 months following the training
- Certification and development path
- Educational support, a list is provided to you for each training as well as the corresponding musical playlist

3- Our programs

Designed in partnership with physiotherapists and following numerous physiological studies

Syncho Swim Sound is a built-in underwater on the benefits of water through sport

Level 1 "Beginner": basic training day, 6 hours

Level 2 "Advanced": thematic training, 8 hours

• Aqua bike • Aqua jump • Butterfly • AquaGym • Aquaparcours...

Level 3 "Professional" :

• specialized training, 8 hours • pre/post natal programs • circuit training

• post breast cancer program

• tailor-made program according to your expectations

BABY SWIMMERS & HIS COMFORT

BABY SWIMMERS SAFETY IN THE SHOWER

- Showering and changing are part of the experience
- Safe for parents and babies alike.



SHOWER CHAIRS



Hexa baby chair

STACKABLE up to 8 chairs!

Dimensions (LxDxH) : 60 x 50 x 76 cm. Weight: 3,9 kg.
 Black/gray Reference z195fm212bg
 Black/red Reference z195fm212br

CHANGING TABLES



Changing table

Dimensions (LxDxH): 100 x 65 x 95 cm.
 Comes with mattress.
 Reference z506fe5109



Vertical wall-mounted changing table

It can support a maximum load of 15 kg.
 Dimensions (LxDxH): 40 x 50 x 120 cm. Foldable.
 Vertical Reference z153f113778



Horizontal wall-mounted changing table

It can support a maximum load of 15 kg.
 Dimensions (LxDxH): 56 x 86 x 12 cm. Foldable.
 Horizontal Reference z153f112523



**SECURITY
CHILDREN**

SCHOOL ACTIVITIES

PLATFORM

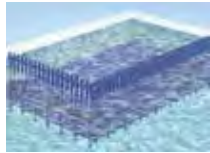

Learning platform

In furniture-style PVC. Lightweight and easy to implement. Various colors available. From 0.5 to 3 m deep, with guardrail or not, module can be added to create a platform of up to 250m². Tailor-made according to your needs.

NC

BABY SWIMMERS EQUIPMENT



Floating Formula 1

Made in Golfoam. 2 nylon axles. Varied colors. Dimensions: 180 x 100 x 80 cm. Reference

z506fd1052



Island with hoops

Made of Golfoam and noodles. Varied colors. Dimensions: 100 x 100 x 65 cm. Reference

z506fd1056



Baby pool basket mat

Made in Golfoam. Baskets included. Varied colors. Double basket Dimensions : 200 x 100 x 6 cm (Also available in 1 basket and 3 baskets). 2 baskets Reference

z506fd109d

FLOATING MAT



Hole mat

Made in Golfoam. Different colors. Different dimensions (contact us). Reference

NC



Floating mat

Made in Golfoam. Different colors. Different dimensions (contact us). Reference

NC



Round relaxation mat

Made in Golfoam. Different colors. 100 x 35 x 3 cm 100 x 45 x 3 cm

Reference z506fd1036

Reference z506fd1037

AQUATIC CAGE/ CIRCUITS

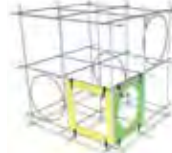

Aquatic cage

Made of aluminum tube. 3 hoops, 1 round entry, 1 square entry included. Dimensions: 200 x 200 x 200 cm. Reference

z506fj263

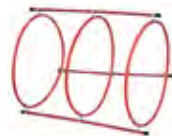

Submersible tunnel

Made of PVC. Dimensions: 100 x 75 cm. Reference

z506fj226



Submersible ark

Made of PVC. Dimensions: 75 x 75 cm. Reference

z506fj256

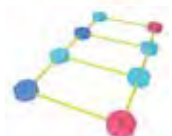

Educational circuit

Made in Golfoam. Octagon (unit). Dimensions: 25 x 25 x 8,5 cm. Reference z506fj251 PVC tube 65 cm Reference z506fj228.1 PVC tube 100 cm Reference z506fj228.3

WEIGHTED GAMES



Weighted algae

For slalom. Made of synthetic textile. For pools from 1.60 m deep. Reference

z506fj215



Submersible fish

Remains in a vertical position at the bottom of the water. Numbered in packs of 6. Different colors. Reference

z506fj255



Marine objects

Made of strong synthetic material. Set of 6 units. Reference

z506fj209

NOODLES

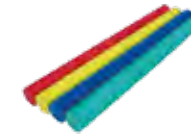

Round noodles

Made from very durable Golfoam. Different colors. 152 x 6.5 cm Reference z506fh948 100 x 4 cm Reference z506fh966 100 x 6.5 cm Reference z506fh987 100 x 7.5 cm Reference z506fh964



Square noodles

Made from very durable Golfoam. Different colors. 100 x 6 x 6 cm Reference z506fh903 200 x 6 x 6 cm Reference z506fh904

Junction system

Joining system for round fries. Made from very durable Golfoam. Dimensions:

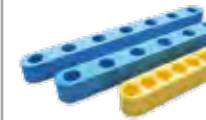

42 x 10 x 9 cm - 3 holes Reference z506fh959 56 x 10 x 9 cm - 4 holes Reference z506fh960 71 x 10 x 9 cm - 5 holes Reference z506fh961 86 x 10 x 9 cm - 6 holes Reference z506fh962 50 x 10 x 4 cm - 7 holes Reference z506fh941 50 x 10 x 9 cm - 7 holes Reference z506fh921 100 x 10 x 9 cm - 7 holes Reference z506fh922

BOARDS



Boards

Made of Retifoam. Dimensions:

Small 29 x 22 x 3 cm Reference z506ft440 Medium 38 x 23 x 3 cm Reference z506ft439 Eurokick 47 x 28 x 3 cm Reference z506ft437



Great board

Made of Retifoam. Dimensions:

Medium 38 x 23 x 4 cm Reference z506ft486 Large 45 x 28 x 4 cm Reference z506ft484 Eurokick 45 x 30 x 4 cm Reference z506ft485



Triangular board

Made of Retifoam.

Multifunction board: pull-buoy, leg/back training and endurance.

Dimensions: 55 x 33 x 4 cm Reference z506ft455

ANTI-SLIP GRATINGS

GRATINGS compliant with standard EN 13451-1



Resists up to 1500 kg per M²



Rigid parallel gratings
Width from 150 to 400 cm



Perpendicular roll-up gratings
from 175 to 900 cm



Curvable gratings
from 180 to 335 cm

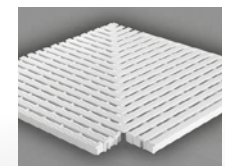

Angles for gratings

GRATINGS COLOR CHART

24 colors available

Light ivory, Cream, Caramel, Brown gray, Brick red, Violet blue, Ocean blue, Chestnut brown, Carmine red, Fuchsia, Yellow, Orange, Concrete gray, Steel, Intense green, Water green, Sky blue, Electric blue, Far Blue, Lead, Deep Black.

Quote based on the length, width, height of the gratings and the connection system...

CONSERVATION AND PROTECTION OF YOUR BASIN SURROUNDINGS

ANTI-SLIP FLOOR

GLISS' PROTECT R13



Application to M². Alkaline, anti-limescale.

CUSTOM MADE COVERS

FOAM COVER



Foam cover 6mm
For swimming pool up to **50 m**



Foam cover 8mm
50 m

BUBBLE COVER



Eco bubble cover
20 m



Hexa «BUBBLE DISC»
Multi shape basins

WINTERING



Winterizing net
Custom made



Winterizing float

SPA



SPA cover

Multi shape basins

CUSTOM MADE REELS

DECA 20 REELS



For bassin

up to 20m

DECA 25 REELS



For bassin

up to 25m

DECA 50 REELS



For bassin

up to 50m

info@myhexagone.com - 01 34 34 11 55



CUSTOM MADE GRATING, PERPENDICULAR, PARALLEL OR CURVABLE

DON'T NEGLECT YOUR BASSIN SURROUNDINGS

- **Withstands up to 1500 kg per M²**
- The gratings are tailor-made, adapted to the shapes and specificities of your pool
- With their non-slip grooves they reduce the risk of sliding at the edge of the pool

Great variety of colors!



100% RECYCLABLE

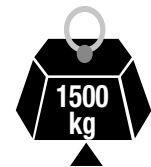

SAFETY FOCUS



Gutter gratings, aesthetic, custom-made and anti-slip

GRATINGS

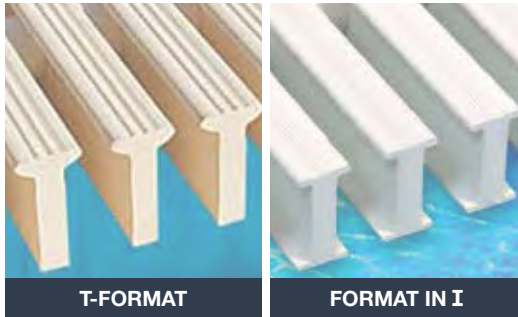

YOU CHOOSE:
Parallel, perpendicular or curved gratings

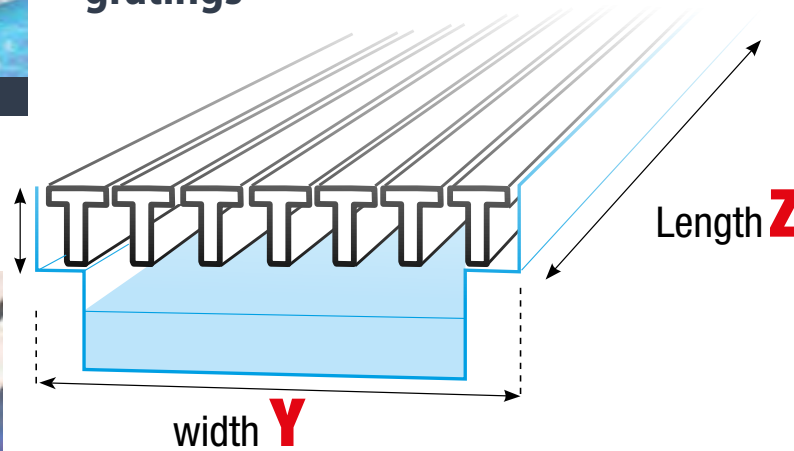
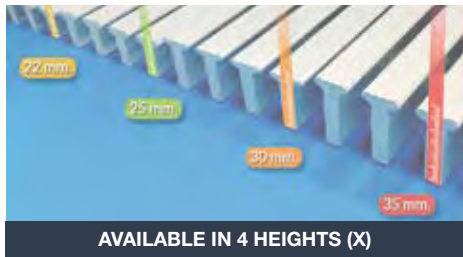

CUSTOM-MADE GRATINGS



Parallel gratings

Height (x)	Width (y)	Length (z)
25 mm in I	from 150 to 400 mm	1 m elements
25 mm PVC	standard 245 mm	elements 250 mm
25 mm PP	standard 245 mm	elements 500 mm
25 mm	182, 254, 330 mm	elements 333 mm
35 mm in T	from 150 to 400 mm	1 m elements

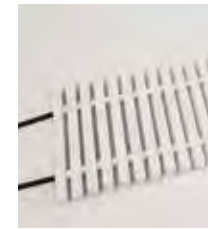

Perpendicular gratings

Height (x)	Rigid (y)	Curvable (y)
22 mm	from 175 to 295 mm	from 150 to 295 mm
25 mm	from 175 to 400 mm	from 150 to 330 mm
30 mm	from 175 to 500 mm	from 150 to 330 mm
35 mm	from 175 to 900 mm	from 150 to 330 mm
Length (z)	in standard sections 2.5 m	in standard sections 1 m



Curvable gratings

Height (x)	Width (y)	Length (z)
25 mm	180, 200, 205, 250, 300 mm	1 m segments
35 mm	195, 245, 295, 335 mm	1 m segments

ANGLES FOR GRATINGS

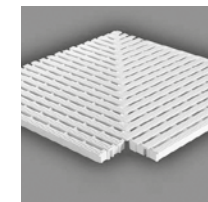

Perpendicular

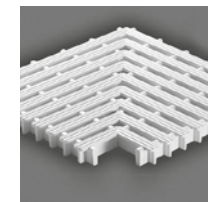

Parallel

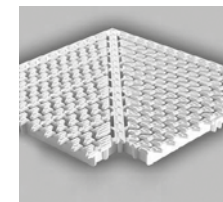

Curvable

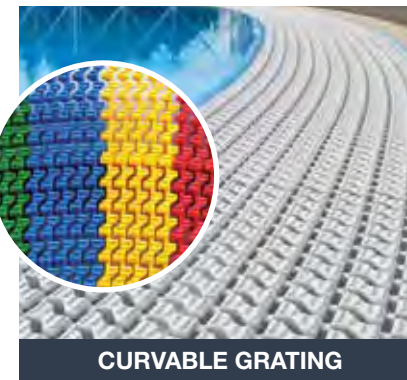

FACILITY

We take care of your gratings project from A to Z (study, costing, installation and placement).

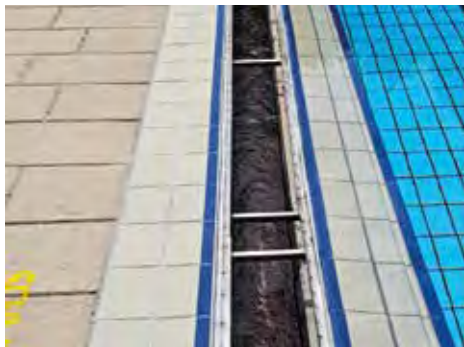
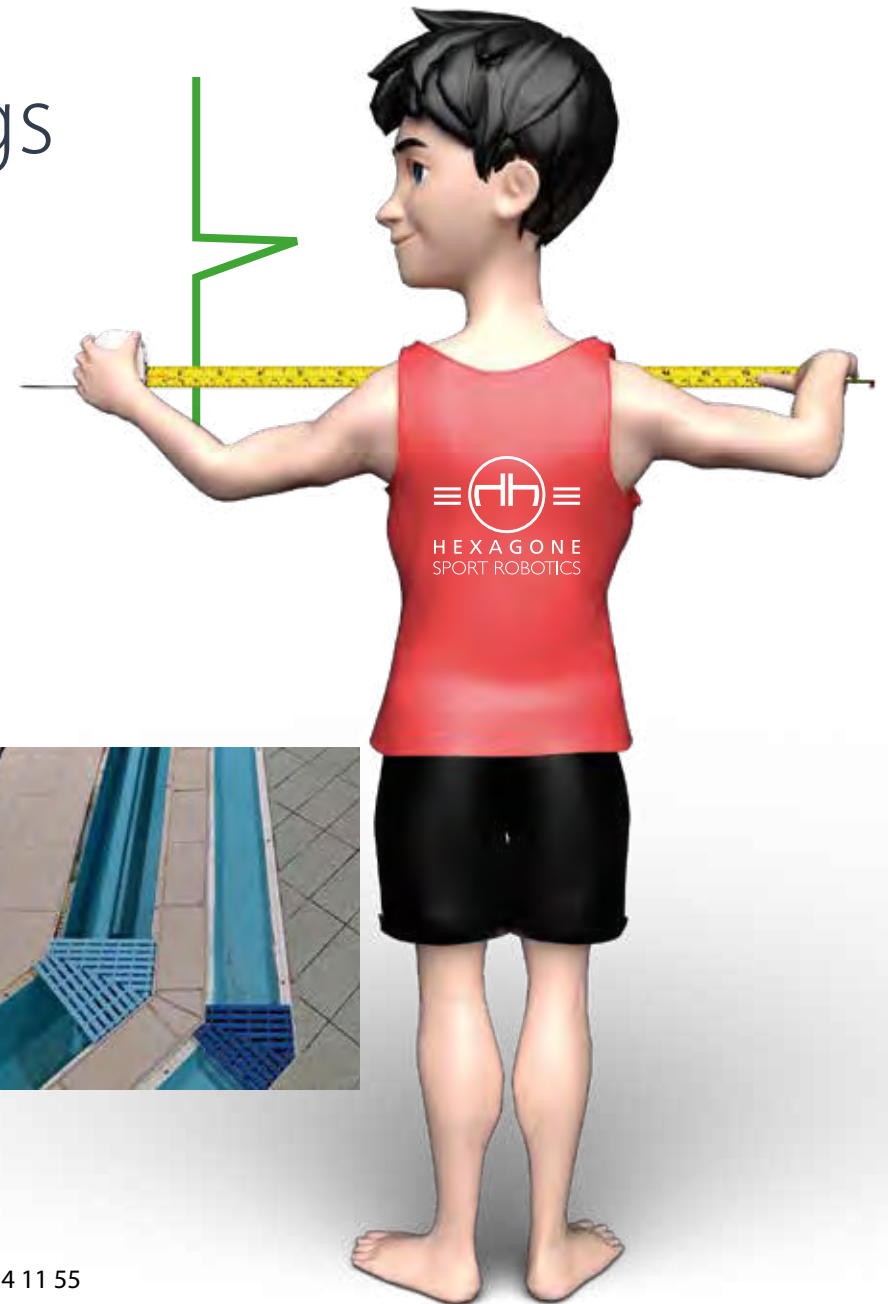

CUSTOM MADE

GRATINGS
MEASUREMENTS

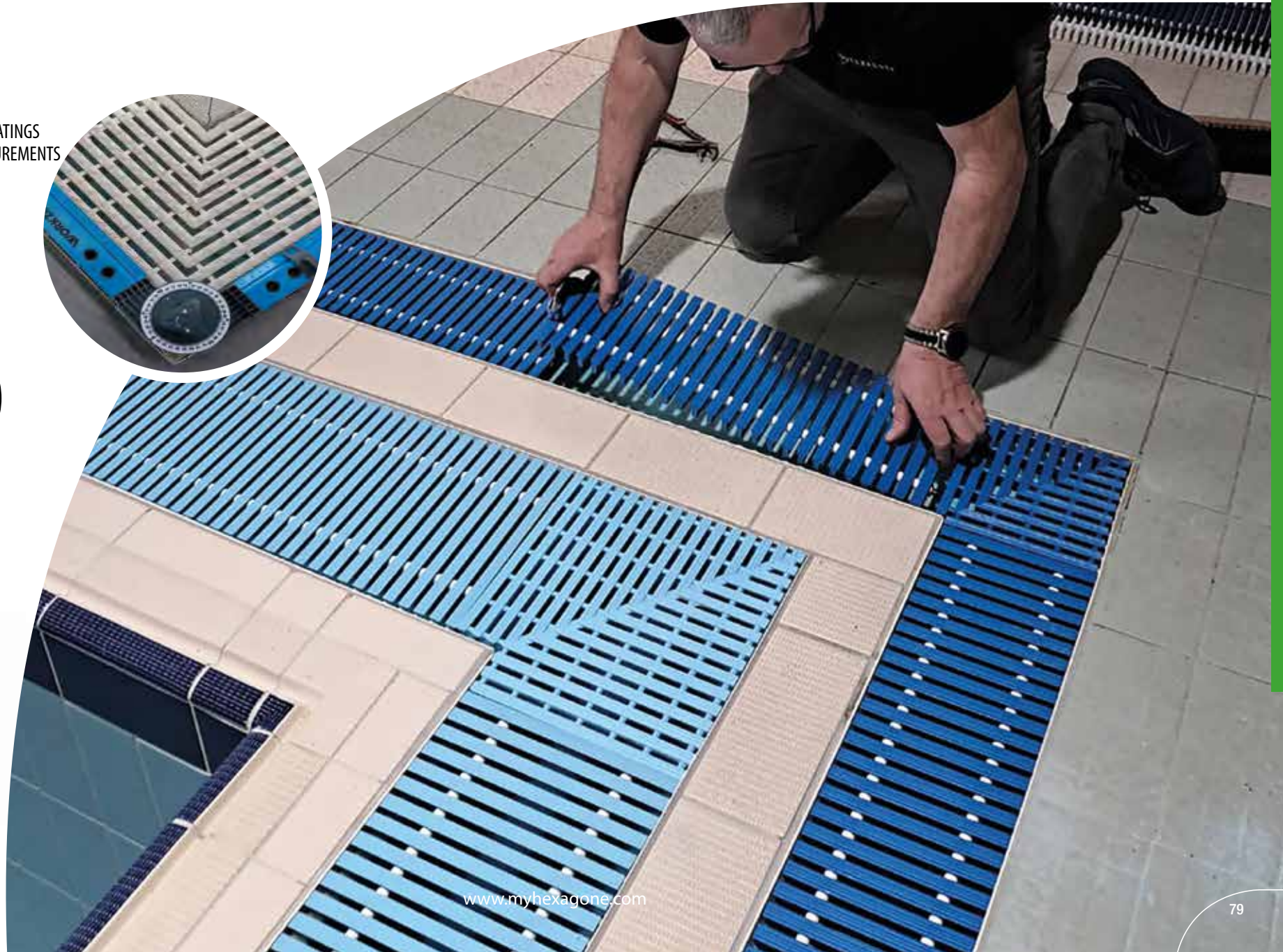
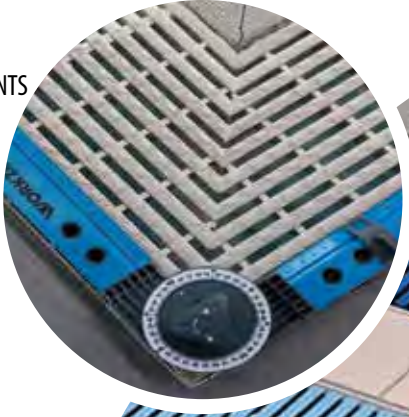

www.myhexagone.com



30,000 PASSAGE GUARANTEE
SCRUBBER DRYERS
OR HIGH PRESSURE CLEANERS

Numerous
references

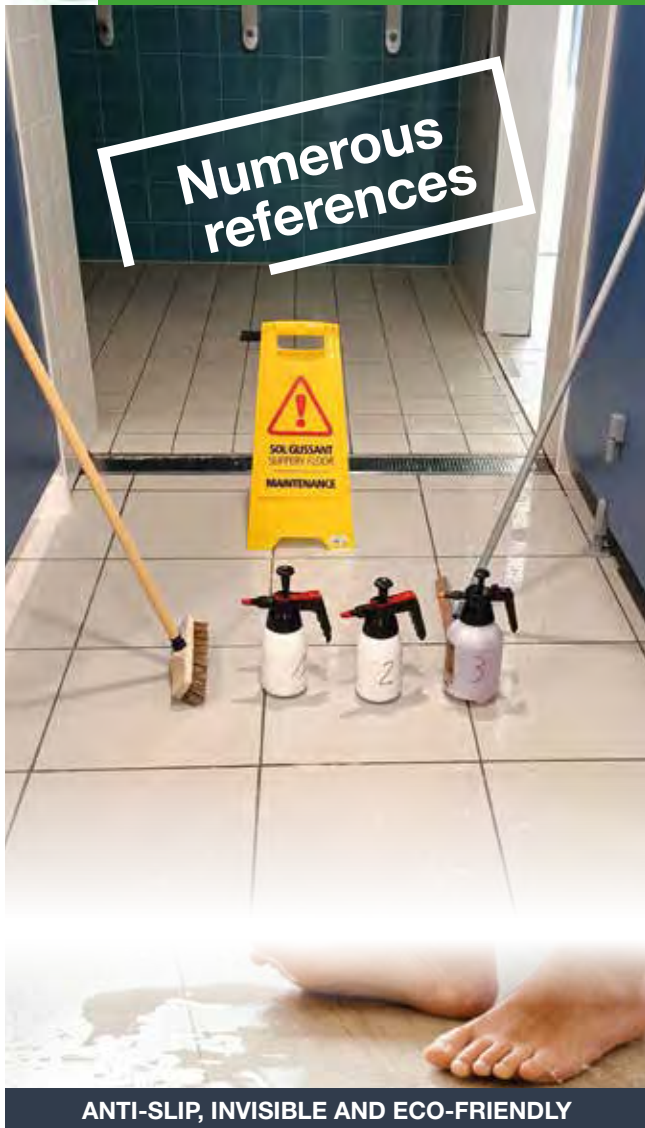

ANTI-SLIP, INVISIBLE AND ECO-FRIENDLY

Accidents are not unavoidable

**PRODUCT
PATENTED**

**PROVISION OF SERVICE IN HEXAGON AND
IMPLEMENTATION WITHOUT WORK HOW DOES IT WORK?**

THE R13 SYSTEM IS COMPOSED OF 3 PRODUCTS :



Deep cleaning

N°1

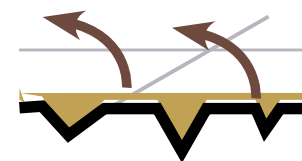

Deep cleaning phase with R13
alkaline and anti-limescale chemical
product N°1.
Removes dirt from tile pores.



Installation of the R13 product

N°2

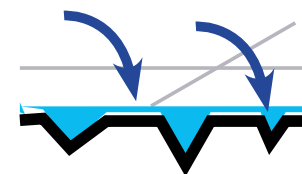

Filling the pores of the tiles with the
antislip product N°2.
Avoids clogging of the tiles.

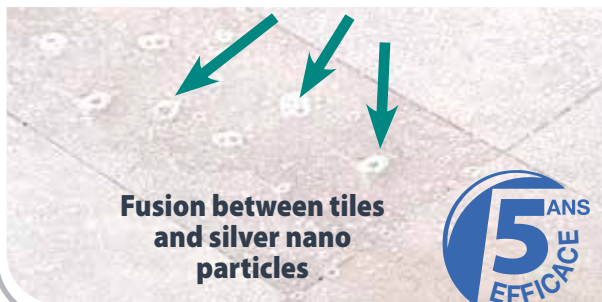

Fusion between tiles
and silver nano
particles



Crystallization of product R13

N°3

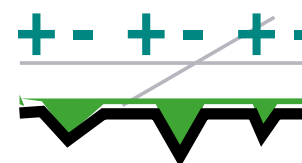

Crystallization and stabilization of the
product for a minimum of 5 years.

Product activation

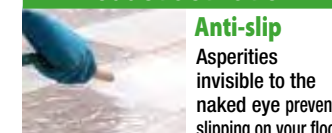

Anti-slip
Asperities
invisible to the
naked eye prevent
slipping on your floor.

GLISS' PROTECT R13



**FLOOR SAFETY IS NOT A TIP,
BUT A LEGAL OBLIGATION!**

ANTI-SLIP SYSTEM FOR EXISTING TILES

- **Rapid application 50m²/h**
- Invisible, safe and economical product
- Durable, your non-slip floors are guaranteed for 5 years
- Avoid changing your tiling and the work that goes with it
- **Reduce the risk of falls for your users and agents.**

-80%
↓
slipperiness

6 X
MORE ECONOMICAL.
ECOLOGICAL,
COMPLIANT
WITH STANDARD
NF EN 15288-1

info@myhexagone.com - 01 34 34 11 55



THERMAL COVER

SAVINGS

WHY IMPLEMENT COVERAGE?

What are heat losses?

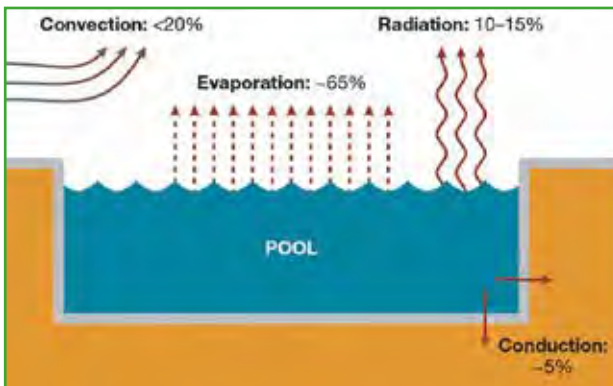

- **Evaporation:** up to 70% of heat loss, evaporation is the main cause of water loss in a swimming pool.
- **Thermal radiation:** up to 25% thermal loss. Any body emits therefore naturally loses heat. Water is no exception. Clear nights accentuate this phenomenon, and the sun's radiation is not enough to counterbalance it during the day.
- **Heat transfer by convection:** up to 25% loss, the heat of the water escapes by convection with the cooler ambient air. The effect is accentuated by the wind.
- **Conduction** is heat transfer due to direct contact between materials.

QUICK RETURN ON INVESTMENT

Your facility can start **saving money** as soon as **the thermal blanket is in place**. In most cases, a pool can **recoup its investment in a cover system between 12 to 24 months**.

Regular use of a thermal pool cover **insulates the pool** during off-peak hours and can therefore **reduce heating costs**, chemicals, water changes and cleaning time.

By reducing the phenomena of evaporation and water renewal (several m^3 per year varying depending on your pool), you **reduce your water bill**.

By **reducing** heat losses and the supply of renewal water, you **heat less**, therefore you **reduce your electricity consumption**.

Here are measurable and measurable savings!!!

CONSUME LESS WATER AND SAVE ENERGY BY INSTALLING A COVER.

REDUCE YOUR OPERATING COSTS

• Reduce evaporation from the pool.

During periods of high heat, **the water in your pool evaporates**.

This is particularly the case at the start of the night, when the outside temperature drops and becomes lower than that of the water. **Evaporation should not be taken lightly as it is the main cause of water loss.**

CUSTOM-MADE SHAPES

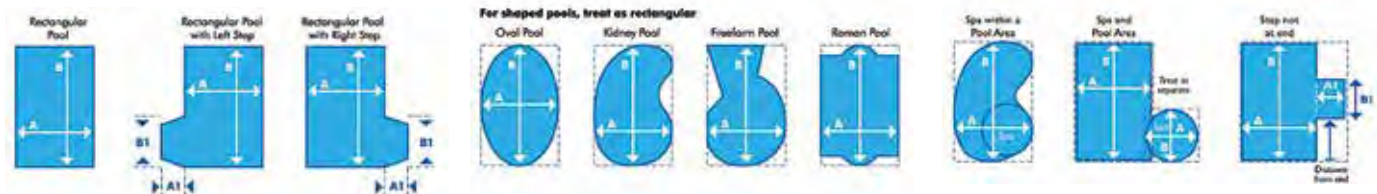

AND ITS IMPLEMENTATION



**CUSTOM
MADE**

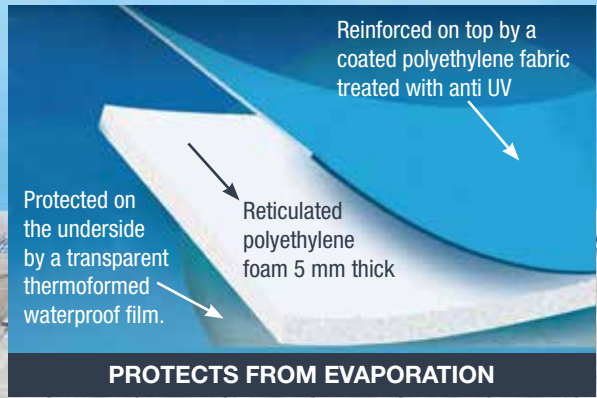

www.myhexagone.com

CUSTOM MADE



YOU WILL USE THE COVER ONLY IF IT IS EASY TO IMPLEMENT,

THE CHOICE OF THE COVER (length/width) DETERMINE WHICH REEL NEEDED

- Are you more motorized or manual?
- Mobile or fixed?
- More than 250 configurations

**SAVE WATER
AND ENERGY**



REELS & COVERS

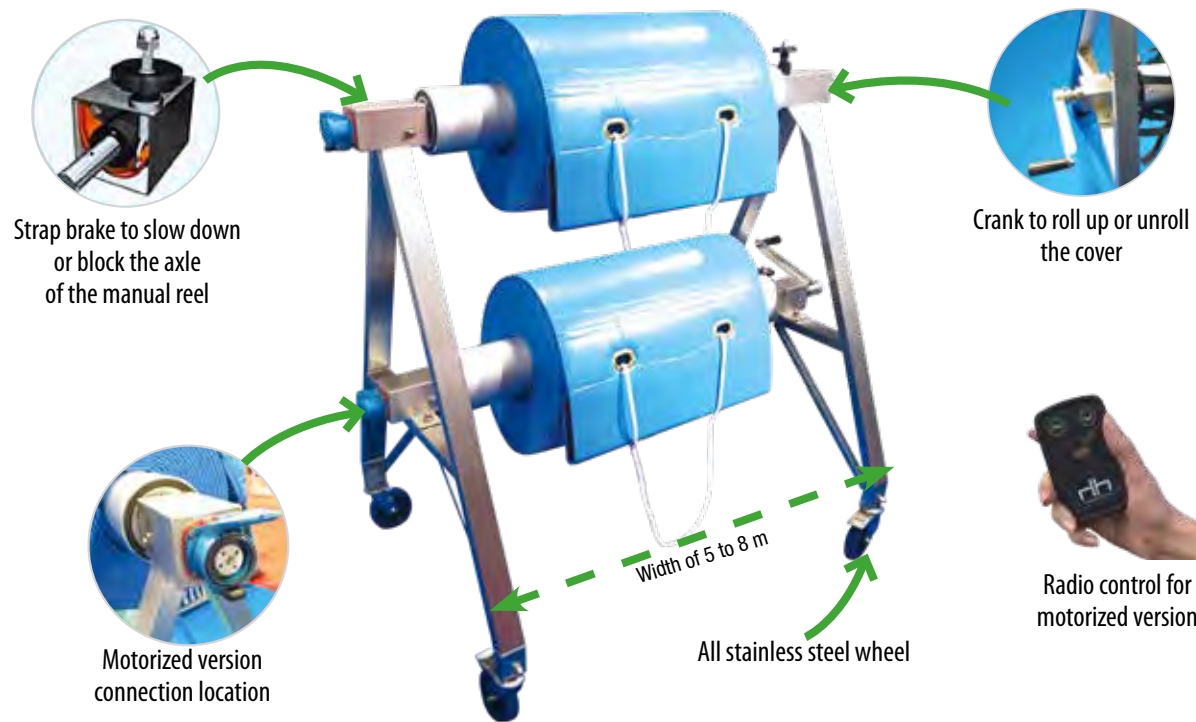

MANUAL OR MOTORIZED MOBILE REELS

DECA 20
for pools up to 20m



Cover
Strip from 1.75 to 5m x 18m

DECA 25 double
for pools up to 25m



Cover
Strip of 5, 6.5 or 8m x 25m

DECA 50
for pools up to 50m



Cover
Strip of 5, 6.5 or 8m x 50m

Configure your reel according to your needs and constraints. Desired mast width, contact us.

www.myhexagone.com

COVERS/TARPS



Foam cover 6mm

6mm. Lined around the entire perimeter.
Blue color.
Reference z218f75009 per M²



8mm foam cover

8mm. Bordered on both widths.
For swimming pools up to 50m. Closed cell foam.
Blue color.
Reference z074v-sim002200 per M²



ECO bubble cover

400 gr/M²
For swimming pools up to 20 m. Soft bubbles.
Translucent.
Reference custom-made NC per M²

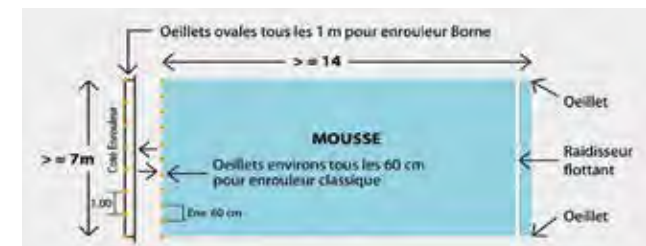

Floating stiffener

For large "foam" covers. Positioned on the width opposite the roller, it makes it easier to handle the tarpaulin without it sinking into the water. We can only make stiffeners on the straight parts.
Rounded roofs cannot be manufactured with a floating stiffener.
Reference z218f79901 per M²



Winterizing net

235 gr/M². In polyethylene. Fixings suitable for wooden or concrete surfaces. Opacity of 89% to combat photosynthesis while allowing water to flow.
Reference z074fv-shfs30100 per M²



Winter float

During periods of frost, the ice compresses the float which thus absorbs the thrust of the ice. The winter floats are attached to each other to form a chain that is installed diagonally across the pool.
Reference z218f65135n

BE UP TO DATE WITH THE HEALTH RECORD

**Essential for having beautiful
and healthy
water, peace of mind...**

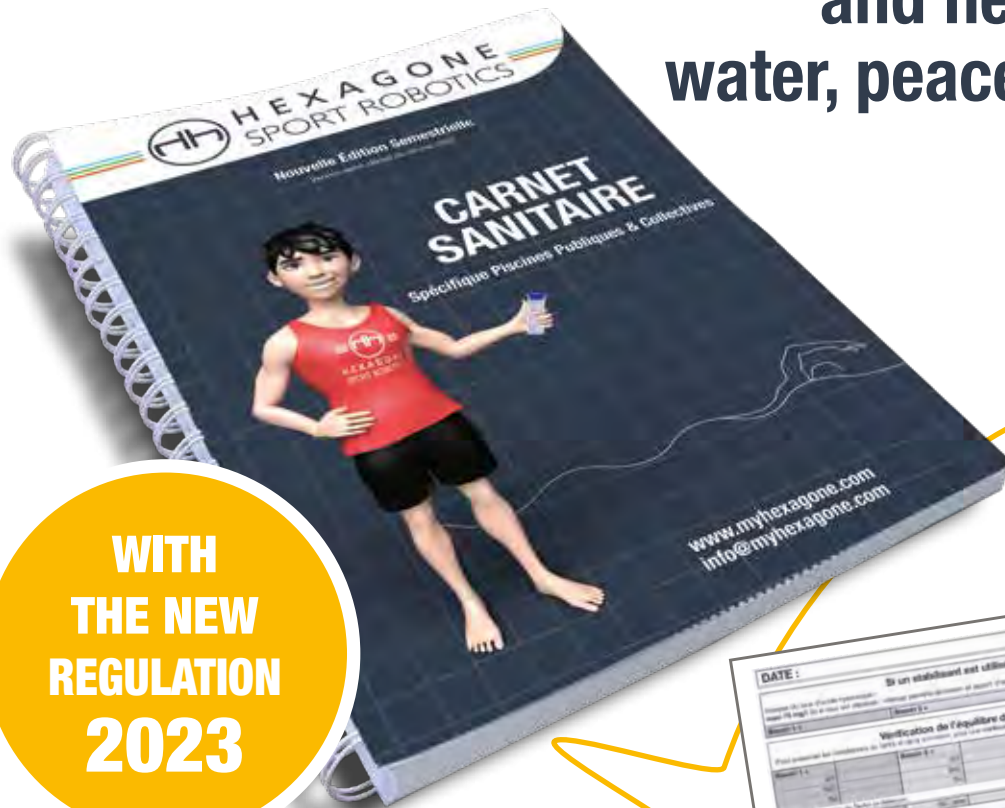

Daily analysis record
for 20 weeks

DATE :		Météo		Température d'air extérieur / Vent		Apert ouvert / M. journal		Eto de parties	
<p>RELEVÉ DE LA QUALITÉ DE L'EAU</p> <p>Station de mesure de la qualité de l'eau</p> <p>Base de données : B</p> <p>Point de mesure : A</p> <p>Compartiment de mesure : B - B1 - C</p> <p>Concentration par jour et par semaine : C1 - C2 - C3 - C4 - C5</p> <p>Diagnostiqueur : A - B - C - D</p>									
Bassin 1		Bassin 2		Bassin 3		Bassin 4		Technicien	
Apert ouvert	M. journal	Eto de parties	Apert ouvert	M. journal	Eto de parties	Apert ouvert	M. journal	Eto de parties	
<p>RELEVÉ DE LA QUALITÉ DE L'AIR</p> <p>Station de mesure de la qualité de l'air</p> <p>Base de données : B</p> <p>Point de mesure : A</p> <p>Compartiment de mesure : B - B1 - C</p> <p>Concentration par jour et par semaine : C1 - C2 - C3 - C4 - C5</p> <p>Diagnostiqueur : A - B - C - D</p>									
<p>RELEVÉ DE LA QUALITÉ DE L'EAU (Suite)</p> <p>Station de mesure de la qualité de l'eau</p> <p>Base de données : B</p> <p>Point de mesure : A</p> <p>Compartiment de mesure : B - B1 - C</p> <p>Concentration par jour et par semaine : C1 - C2 - C3 - C4 - C5</p> <p>Diagnostiqueur : A - B - C - D</p>									

**WITH
THE NEW
REGULATION
2023**

The public or residential swimming pool agenda. Each page allows you to note down your observations and analysis reports over the 7 days of the week.

Reference ud1000n002

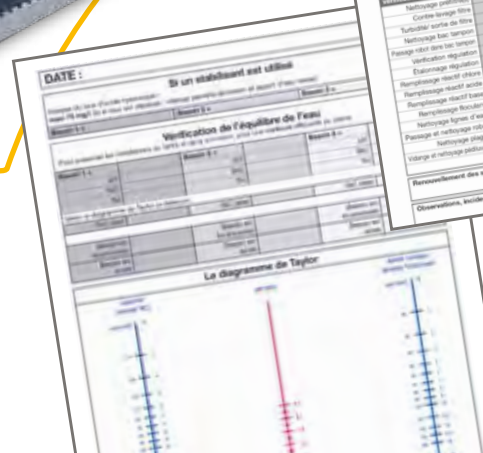

Weekly analysis report,
Taylor chart
for 20 weeks



App free calculation of active chlorine

DISINFECTION AND PROTECTION

REGULATION & DOSAGE

REGULATION



Chlorine/pH regulation



Pedichlor



Metering pumps



Transfer pumps

PUMPS

DOSING/RETENTION/STORAGE BINS



Dosing bins



Safety bins



Retention Pallet



Storage bins

WATER ANALYSIS

HEALTH RECORD & ACCESSORIES



Health record



Municipal kit



Test tubes



Sampling pole

PROTECTION & NEBULIZATION

PROTECTION EPI



Gas mask



PVC apron



Chemistry glove



Overshoes

PHOTOMETERS/TURBIDIMETER

THERMOMETERS

NEBULIZATION / DISINFECTION



Photometers



Turbidity analyzer



Lozenges



Buoy thermometer



Classic thermometer



MOZONE



SANI-ZOOM



SANI-ZOOM product

You are not decided, you want another product, do not hesitate to contact us...

ESSENTIAL, the complete analysis case...

MUNICIPAL KIT



Colorimetric comparator

Colorimeter, comparator, discs, 6 functions. Square test tubes, accessories. Analysis of Chlorine, pH, TAC, TH Calcium and Stabilizer (Cyanuric Acid).

Reference z276fsp129c

THERMOMETERS



Buoy thermometer

Floating thermometer.

Reference z506fmc814



Classic thermometer

Anchor thermometer.

Reference z218f46583



Electronic thermometer

Reference z368fhi98509n

PHOTOMETRIC ACCESSORIES



Round test tube

10ml. Glass. Set of 5.

Large z276hpt595uni

Wide z276hpt555uni



Square test tube

10ml. Glass. Set of 5.

Reference z276fpt521/5

SAMPLING POLE

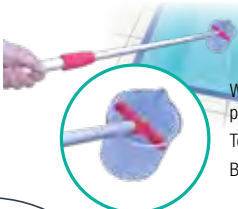

Telescopic pole

With telescopic pole 1.5/2.5 m and beaker with 600 ml pouring spout.

Telescopic boom z251fbur-53550250

Beaker with pouring spout z251fbur-53545050



PC ANALYSIS calibration for almost all **LOVIBOND** and **PALINTEST** brands (excluding Swan and Hanna)

We will arrange to send you a carrier and we will return the device to you once calibrated.

PHOTOMETERS



PC 03 photometer

Quickly and reliably analyze the following test parameters: Chlorine 0 - 5 mg/l. Chlorine 0 - 10 mg/l. Cyanuric Acid 0 - 100 mg/l (stabilizer). Phenol red pH 6.5 - 8.4.

Reference z276fmp003

PC 04 photometer

Quickly and reliably analyze the following test parameters:

Bromine 0 - 10 mg/l. Chlorine 0 - 5 mg/l. Chlorine 0 - 10 mg/l. Phenol red pH 6.5 - 8.4. Total alkalinity 0 - 500 mg/l.

Reference z276fmp004

PC 06 photometer

Complete water balance calculation, with tests for alkalinity, bromine, calcium hardness, chlorine, cyanuric acid and pH. Quickly and reliably analyze the following test parameters: Bromine 0 - 10 mg/l. Calcium hardness 0 - 500 mg/L. Chlorine 0 - 5 mg/l. Chlorine 0 - 10 mg/l. Cyanuric acid 0 - 150 mg/l. Phenol red pH 6.5 - 8.4. Total alkalinity 0 - 500 mg/l.

Reference z276fmp006

TURBIDITY ANALYZER



Turbidimeter **NEW MEASUREMENT**

Mandatory analysis following decree n°2021-656. Measures water turbidity. Power supply 2x 1.5V 'AA' alkaline battery. Dimensions: 82 x 225 x 50 mm. Stores up to 1000 sets of data.

Reference z276fph092



REACTIVES

Pastille

DPD 1

Box of 250.

Black for photometer
z276fap011

Manual green
z276fat010

DPD 3

Box of 250.

Black for photometer
z276fap031/1

Manual green
z276fat030

DPD 4

Box of 250.

Black for photometer
z276fat041

Manual green
z276fat040

DPD stabilizer

Box of 100.
z276fap087

Box of 250.
NC

DPD Phenol red

Box of 250.

Black for photometer
z276fap130

Manual green
z276fat130

WATER ANALYSIS

COMPREHENSIVE WATER BALANCE ANALYSIS

RELIABLE WATER QUALITY ASSESSMENTS

- **Easy to use: quality analysis in 2 minutes**
- Trusted technology, using the standard DPD method worldwide
- Bluetooth connectivity to communicate analysis results

The guarantee of a healthy swimming pool!



www.myhexagone.com





HEXACONTROL, EASY REGULATION AND DOSING

MORE THAN 3000 FACILITIES IN FRANCE

- Chlorine/pH regulation with large figures
- For daily measurement reliability
- Integrated sampling
- Ideal in dark technical rooms

For more beautiful and healthier water!

FABRIQUÉ
EN FRANCE



PROBE BLOCK
AMPEROMETRIC



RÉGULATION & DOSAGE

REGULATION



Cl/pH amperometric regulation

- This regulation has an amperometric measurement of chlorine with 2 injection thresholds and 2 injection thresholds for pH.
- Display 6 cm high and 2 different colors.

Complete Cl/pH regulation	Reference	z243hzc0012n001
Complete Cl regulation	Reference	z243hzc0010n000
Complete pH regulation	Reference	z243hzc0002n000



Probes

Cl probe	Référence	z243f5636ccp
Cl probe with wire	Référence	z243f963sa
Universal pH probe	Référence	z245f1150112

PEDICHLOR



Pedichlor

Chlorine doser for footbath. In 250 gr pebble

Reference	z238f7000014
-----------	--------------



Chlorinator

Chlorine and bromine distributor. In ABS. Capacity 4 kg of tablets. Regulating valves.

Reference	z218f24429
-----------	------------

TRANSFER PUMPS



Motorized transfer pump

Suitable for cans of 20 to 200 liters.
Reference z206f31441010 alone
Reference z206f31443010 complete



Manual transfer pump

Injection cane
Reference z188f802.100.300

DOSING PUMPS



Peristaltic dosing pump

Flow rate: 0.1 - 10 l/h. Pressure: 0.1 - 3 bar.
Materials of parts in contact with the fluid: polypropylene (head), SekoFlex and SekoBril (tube). Power supply: 90-265 V 50/60 Hz. Protection rating: IP65
Reference z237fpe001ha1009



Dosing pump

It allows liquid products such as pH corrector to be injected. It can be controlled by regulation for chlorine and pH.
5 liters/h Reference z237fakl603nhh0000
10 liters/h Reference z237fakl800nhh0000
20 to 110 liters/h Reference z237fakl803nhh0000



Kompact dosing pump

Flow range: up to 5 l/h. Pressure: up to 10 bar. Parts in contact with the fluid: PVDF-T, PTFE, EPDM, FPM and ceramic. Analogue and digital range with constant or proportional dosage.
Reference z237ftck603nhh0000



Tubing and strainers

Essential in maintaining precise dosing, these tubes and strainers are fully tested for durability and compatibility with the various controls and pumps in our catalog.

Reference	NC (contact us)
-----------	-----------------

DOSAGE BINS



Packing bins

Polyethylene dosing tray allows you to store a quantity of 50 to 250 liters of liquid products in complete safety. The solution will be injected by a dosing pump.

50 liter bin	Reference	z218f57613
100 liter bin	Reference	z218f46562r
250 liter bin	Reference	z218f01315

SAFETY/RETENTION BIN



Safety bin

The retention bins provide security in the event of damage to the storage bin. The contents of the bin cannot overflow onto the ground. The small 60 liter safety container alone is suitable for securing cans of products used directly: Chloroliquide, pH Minus etc.
60 liters Reference z218fsng0050
100 liters Reference z218fsng0110
250 liters Reference z218fsng0250



Retention Pallet

Manufactured from polyethylene (PE). Retention capacity 230 liters with removable PE grating and double fork passage. Dimensions: 1220 x 820 x 450 mm. Weight: 27 kg.

Reference	z246f95300400
-----------	---------------

STORAGE



Tray with grating

Available in 13L, 28L, 39L, 60L, 87L et 143L.

Reference	NC
-----------	----



Tray without grating

Available in 10L, 20L, 30L, 40L, 60L et 100L.

Reference	NC
-----------	----

PORTABLE NEBULIZATION



SANI-ZOOM 1L

Misting on demand. Compatible with most disinfectants.
Very light - 300 grams.
Interchangeable 1 liter solution.
Battery life of 1.8 hours continuously.
Homogeneous spraying for total surface coverage.
Ideal changing rooms. Easy to use battery system.
Easy to clean and maintain.
Reference z702fmsstorm



SANI-ZOOM 5L Product

Vendu par bidon de 5 litres. Désinfectant liquide prêt à l'emploi utilisable dans brumisateurs 1,5,10 litres.
Reference z095f002108692

PPE PROTECTION

ESSENTIAL
FOR THE SAFETY
OF YOUR AGENTS



Mask & cartridge

Gas mask alone. Reference z278f1710394
Type B cartridge.. Reference z278f1785030



PVC apron

In PVC. Unique size

Reference z246f9510500001



Chemistry glove

In PVC. Unique size

Reference z246f951060001



Tigerrip overshoes

Safety overshoes.

Yellow Reference z183httprt-34-36-s
Brown Reference z183httprt-37-40-m
Red Reference z183httprt-41-44-l
Green Reference z183httprt-45+-xl

MO2ONE, disinfection of your gymnasiums and sports facilities



Emergency stop button
Indication visible on the screen



2 360° rotating nozzles



Cleaning control report
via USB stick



Touch screen for MO2ONE
control and configuration

MO2ONE



MO2ONE

Dimensions (Lx W x H)
Weight
Frame
Electric blower
Rotation speed
Adjustable liquid flow
Fog exit speed
Product capacity
Power supply
Reference

65 x 60 x 70,5 cm
49 kg with empty tanks
Stainless steel
2 x 1500 W
2 rpm
15 to 30 ml/min
40 m/sec
2 x 5L cans
230 V
xymo2one

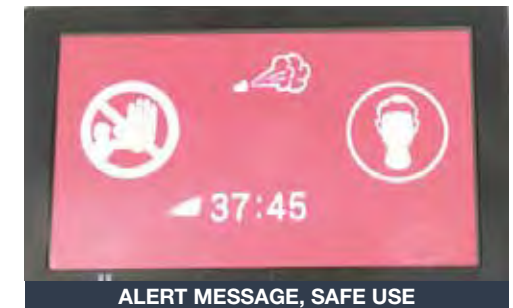

MO2ONE, ENSURES THE DISINFECTION OF LARGE VOLUME SURFACES.

BIO-DISINFECTION DEVICE

- Diffusion of dry fog
- Treats each cm^2 of surfaces, preventively or curatively
- Dry fog which degrades naturally without leaving any residue and without corroding surfaces
- **Treatment of volumes from 500 to 20,000 m^3**



www.myhexagone.com



JIMMY, autonomous scrubber dryer for gymnasium



BATTERY DISTRIBUTION, MOTOR, CENTER OF GRAVITY, STABLE MACHINE



SOFT FLOOR GYMNASIUM



HARD GROUND GYMNASIUM

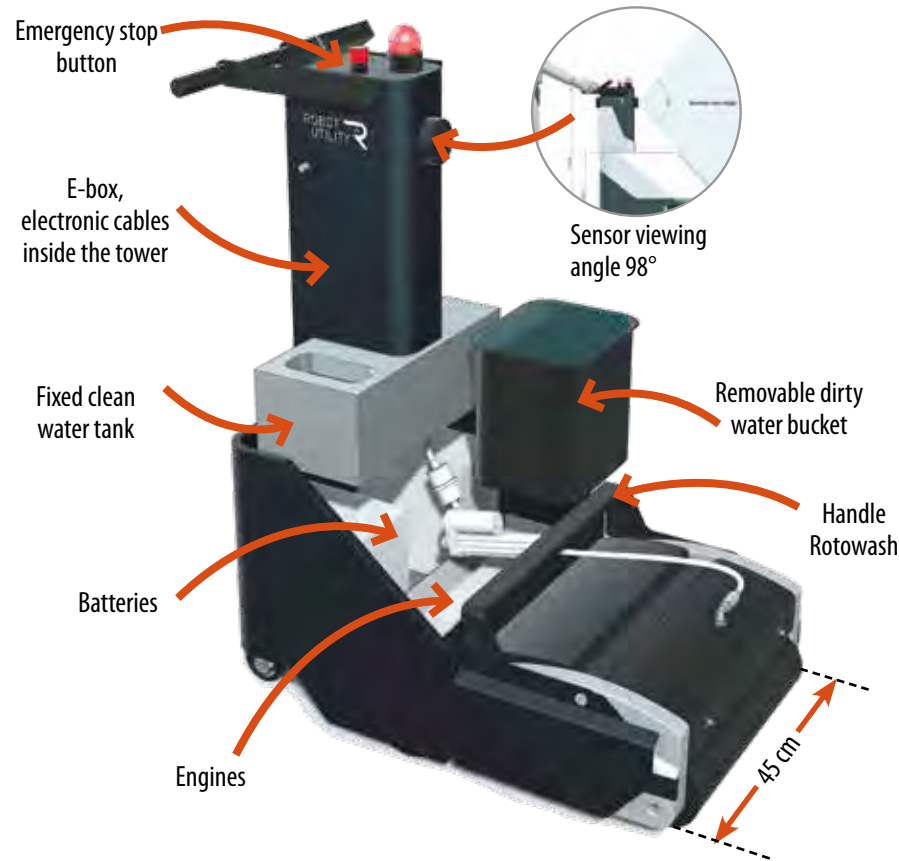

Opening hood for easy maintenance access



JIMMY SCRUBBER DRYER

*Available from September 2024



JIMMY

• Autonomous robot for cleaning indoor sports surfaces.

Dimensions (Lx D x H)	107 x 86 x 67,3 cm
Weight	70 kg with empty tanks
Brush width	45 cm
Tank capacity	14 liters
Capacity of the recovery tank	10 liters
Hard ground autonomy	2h
Textile floor autonomy	1h30'
Cooldown time	4h
Power supply	2 12 V traction batteries
Référence	xjimmy

The robot that lets you clean the gym while it's closed

Increasingly in demand, maintenance must adapt to new uses.

Allows you to clean immediately after a competition or overnight.

Removes most of the resin from balloons.

Ideal for synthetic surfaces and parquet.

Dual operation, automatic or like a classic scrubber dryer with agent.

**CLEANING OF
SPORTS SURFACES
INDOOR**

FABRIQUÉ
EN FRANCE



FABRIQUÉ
EN FRANCE



Ensuring the playing quality of your synthetic turf on a daily basis

Robotization helps you maintain your regulatory compliance

Efficient, regular maintenance without risk of fiber damage

- Improves playability (ball roll, ball bounce, vertical deformation and rotational resistance).
- Reduces the risk of injuries (sprain, fracture and cuts)
- Maintains the longevity and quality of the playing surface (density, fiber strength, homogeneity)
- Contributes to better cushioning of the installation (increases the lifespan of the carpet)
- Provides an electronic logbook of your (better monitoring) maintenance cycles
- Allows you to maintain the playing area and its surroundings (assistant referee corridors, warm-up areas, behind the goals, sidelines)
- Avoids the scattering of fiber filaments as well as granulate outside the playing area

Switch to robotization
for the maintenance
of your synthetic fields



BUKY ONE, your daily maintenance robot for artificial grass

BUKY ONE

OUR 3 TOOLS

The depth of the brush or the claws adjusts according to your terrain and its condition

Brush to straighten the fiber

- Brush widths: 120 cm
- Nylon brush

ECOLOGICAL:

Captures used fiber filaments and prevents them from being scattered in nature.



Decompression of the filling material

- Decompaction with adjustable depth

ECOLOGICAL:

Brings the aggregate back to the center of the ground and prevents it from being sprayed outside.



Magnet for metal pick-up

- Attracts small metal objects (hair clips, barrettes, fence hooks, etc.) thus reducing the risk of cuts.



ROBOT UTILITY TECHNOLOGY

Intelligent itinerary, by orderly work from A to Z, with emphasis on the key lines to bring back the aggregate



Autonomous GPS/RTK system



With color touch screen interface and Bluetooth app

Can be used as a radio control for specific work on an area



Returns to your defined parking area alone after work

Claw (or brush) + magnet
Breaks down the filling material

Safety bumpers
Obstacle detection



SECURITY

BUKY ONE ROBOT BRUSH



BUKY ONE

Dimensions (Lx Dx H)	1225 x 1486 x 934 mm
Weight	175 kg (203 kg with tools)
Autonomy (in time)	4h30 min.
Autonomy (on the surface)	2350 m ² /h
Cooldown time	8h / 230V
Power supply	2 x 24V Battery pack ATB
Reference	xybuky06h
Delivered with charger + radio control + brush + magnet + claw	



www.myhexagone.com

7 SUBSIDIARIES IN EUROPE

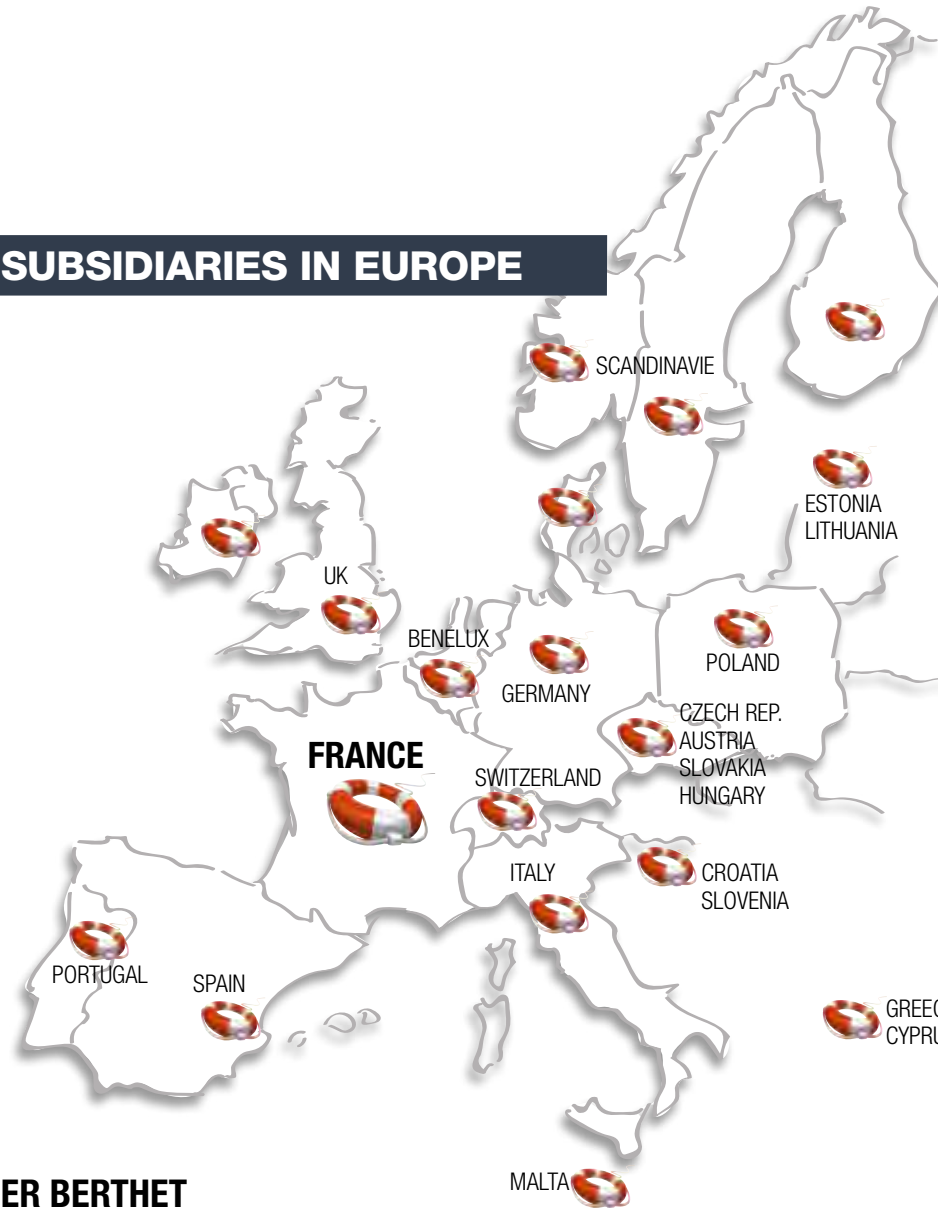

55 DISTRIBUTORS AROUND THE WORLD

USA / LATIN AMERICA

17 US REGIONAL DISTRIBUTORS



AFRICA / MIDDLE EAST

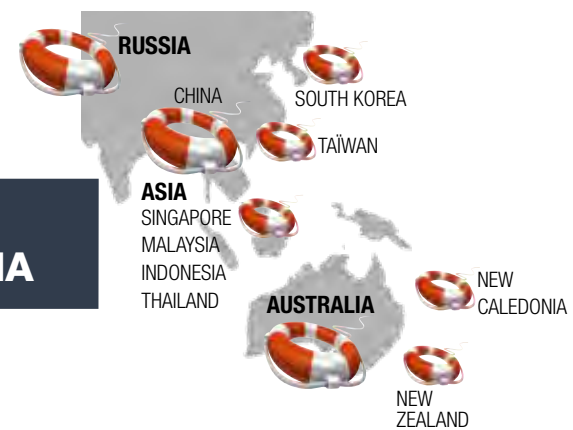

ASIA / AUSTRALIA



OLIVIER BERTHET
Export Manager

GENERAL CONDITIONS OF SALE HEXAGONE MANUFACTURE S.A.S

I GENERAL SALES PROVISIONS:

I.1. APPLICATION AND ENFORCEABILITY OF THESE GENERAL CONDITIONS

These general conditions of sale (hereafter, "GCS") apply systematically to every buyer (hereafter "the Customer") with the current Hexagone Manufacture S.A.S. tariff, allowing him/her to place an order. As a result, the fact of placing an order implies full acceptance without reservation by the Customer of the GCS. No specific condition may, except in cases of formal and written acceptance from Hexagone Manufacture S.A.S., prevail over the GCS. In the absence of express acceptance, no contrary condition may be raised in objection with Hexagone Manufacture S.A.S. by the Customer, regardless of the time when it may have been brought to its knowledge.

The fact that Hexagone Manufacture S.A.S. does not avail itself at any given moment of any one of these GCS may not be interpreted as a waiver of the right to avail itself of this at a later date. These GCS prevail over any Customer general conditions. These GCS apply to all countries.

I.2. ORDER:

Order means any order relating to products which appear in our tariffs, and accepted by Hexagone Manufacture S.A.S.. Offers made by our agents or by telephone shall only constitute a commitment on our side after written confirmation from us. The Customer shall be deemed in agreement with the content of our confirmation if, within eight (8) days, he/she has not shared his/her observations with us in a written registered mail with acknowledgement of receipt. In the absence of any written observation, the order shall be deemed irrevocable. The order is non-transferrable and may not be transferred without the agreement of Hexagone Manufacture S.A.S..

I.3. ORDER FULFILMENTS:

We reserve the right to make any modifications or improvements we deem necessary to our products at any moment, without this serving as grounds for a Customer to cancel an order, or requiring us to make any modifications or improvements to previously-delivered products.

I.4. CANCELLATION OF ORDERS:

No order can be cancelled by our Customers without our prior and express agreement.

In any case where Hexagone Manufacture S.A.S. should accept the cancellation of an order, any deposit paid by the Customer shall be retained by us in compensation.

I.5. DELIVERY:

Deliveries are carried out by freight forwarders either directly to the Customer or via a carrier.

1.5.1. DELIVERY TIMES:

Delivery times as well as transportation times are determined on a case-by-case basis and are entirely indicative and without guarantee. Unless there is a contrary agreement, they shall never constitute a commitment on our side. Any delay to delivery shall not constitute grounds to terminate the order, or grounds for refunds, damages or interests, deductions, compensation, cancellation of the current order or the refusal of goods, as well as any kind of indemnity. In cases of force majeure, and especially: fire, flood, discontinuation of product, machinery breakdown, war, riots, requisition, required reduction of imports, accident or manufacturing delay at our suppliers, delay to transportation of goods, as well as in cases of the occurrence of any event beyond our control which prevents the execution of the contract under normal conditions, whereby manufacture and/or delivery have been prevented or delayed, then our contractual obligations shall be suspended for as long as the case of force majeure exists, without any responsibility borne by Hexagone Manufacture S.A.S., even if a firm timescale has been confirmed. If the case of force majeure should continue for longer than forty-five (45) days, the more diligent party may, if it wishes, cancel the order affected by the case of force majeure without either of the parties laying claim to the payment of damages and interests.

1.5.2. TRANSFER OF RISKS

The transfer to the Customer of risks of loss, theft or damage of goods sold, as well as the damages these may cause, shall be effective from the moment the courier takes possession of the order. The Customer shall, as a result, take out insurance covering these risks pertaining to the reception of goods for delivery by the courier.

1.5.3. TRANSPORT

Unless otherwise stipulated, delivery shall be made by our accredited couriers with shipping costs billed to the Customer in addition to the price paid for the goods. Hexagone Manufacture S.A.S. cannot be held responsible for damage which occurs during transportation or unloading. Goods shall always travel at the Customer's risk, even in case of returns or despatches sent carriage paid or C.O.D. The Customer shall be responsible for checking that the goods are in good condition at the moment of delivery. They shall also check the quality, quantity and reference of goods, as well as that they match the original order. The Customer shall relay, where necessary, any concerns to the courier concerning missing and/or damaged goods, the type of damage and the extent thereof. These concerns must be communicated to the courier by the Customer by extra-judicial act or registered letter with acknowledgement of receipt within three (3) days, not including bank holidays, of the reception of said goods (article L133-3 of the French Code of commerce); one copy shall also be addressed to Hexagone Manufacture S.A.S..

All recourse shall be sought from the carrier. Where, in accordance with reasonable commercial standards, Hexagone Manufacture S.A.S. carries out additional transportation operations, such as loading, wrapping, securing, taking out an insurance policy, customs formalities etc. it shall only act as a representative of the consignee who retains their responsibility for the cost, risks and perils of such operations.

I.6. COMPLAINTS AND RETURN OF GOODS

Without prejudice to claims made against the carrier by the Customer, such as those included in article 1.5.3., in the case of visible defects or missing products, any complaint, whatever its nature, relating to delivered products, shall only be accepted by Hexagone Manufacture S.A.S. if it is made in writing, by registered letter with acknowledgement of receipt, within fifteen (15) days following the delivery date.

No goods may be returned without our express agreement and goods may only be returned if fit for resale. The Customer shall allow Hexagone Manufacture S.A.S. to verify any defects to allow for these to be remedied. He/she shall abstain from intervening themselves or from seeking intervention from a third party. The cost and risk of returns shall be borne by the Customer at all times. Any goods returned without our agreement shall be made available to the Customer and shall not lead to the establishment of an asset. Justified returns shall be subject to a replacement of the product as

deemed most appropriate by Hexagone Manufacture S.A.S. in light of the Customer's needs or, where it is impossible for us to do so, a credit shall be made to the Customer after we have verified the quality of the returned machine, which shall exclude any compensation or damages and interests, deduction of the price of usable accessories, missing equipment and the cost of returning it to good working order. In cases where Hexagone Manufacture S.A.S. accepts the return of goods in conformity with the initial Customer requirements, the purchase price of said goods shall be paid to the Customer to a maximum of 75% of the billed value.

I.7. PRICE AND PAYMENT

1.7.1. Prices, information and technical characteristics which can be found in our catalogues, tariffs, prospectus, technical specifications or other documents are indicative and cannot be deemed firm offers. These documents have no binding nature and can be modified at any moment and without prior notice. Our prices are expressed in Euros. Any taxes, duties or other contributions to be paid in accordance with French legislation and regulations, or those of an importing or transit country shall be borne by the Customer.

1.7.2. Our materials are always billed at the current tariff at the moment when the order is confirmed by Hexagone Manufacture S.A.S., and are less tax from the moment they depart our headquarters in Argenteuil, carriage and packaging not included.

1.7.3. A fixed sum of 21 € less tax on charges for all invoices of under 80 € less tax.

1.7.4. Our invoices are payable upon reception unless a different payment schedule is indicated on the invoice. Only the cashing of a paper instrument or cheque or the reception of a bank transfer shall be considered as valid payment under these GCS. In cases of payment by bills of exchange, the Customer is required to return the accepted paper instruments presented to them within a maximum of seven (7) days. Any amount including tax not paid within the allotted time shall give rise to a payment by the Customer of delay penalties fixed at 3% per month's delay, as well as a fixed rate of compensation to cover losses to our Company of a total of FORTY (40) EUROS. If the recovery costs are greater than the amount of said compensation, our Company shall then seek, with supporting documents, additional compensation (articles L.441-6 et D.441-5 of the code of commerce).

1.7.5. Recourse to our warranty obligation or any other demand of any kind that the Customer may make shall not allow him/her to in any case or under any pretext retain or delay payments owed to us, it is also expressly required that any delay or failure to pay should lead to the ceasing of recourse to our warranty and agreements.

1.7.6. Our sales are made fully and without exception at our Argenteuil headquarters, unless otherwise specified. Acceptance of our bills of exchange or payment by any other means shall not constitute either a renewal of or a derogation from this clause.

1.7.7. Failure to accept our drafts or payment default at the expiry of a bill of exchange or an invoice, and whatever the mode of payment or in cases of cessation of activity or cessation of funds, shall lead to the forfeiture of the term, requiring that all debts to us, including those not yet expired, be paid immediately. It shall also lead to the suspension or resolution of tenders, contracts and orders in progress, without possibility for the Customer to argue an unjustified refusal of sale, or claim any kind of compensation.

1.8. TRANSFER OF PROPERTY – OWNERSHIP RESERVE CLAUSE

Hexagone Manufacture S.A.S. reserves ownership of goods sold until effective payment of the full price for the main goods and accessories, even in cases of granting of payment terms. The Customer may in no case resell, pledge or grant a guarantee on the good delivered and not fully paid for. Payment default on any deadlines may lead to goods being reclaimed. Where reclaims are made, deposits already paid shall be retained by Hexagone Manufacture S.A.S. in compensation.

II WARRANTIES AND RESPONSIBILITIES:

II.1. Goods must be verified by the Customer upon delivery, and any complaint, reservation or dispute relating to missing goods or apparent defects should be made within the provisions of article 1.6. In case of apparent defects, defective parts shall be replaced by Hexagone Manufacture S.A.S. or the goods replaced, subject to verification of the alleged defects. The Customer shall supply any documentation or elements which demonstrate the extent of observed defects. No complaints can be made by the Customer more than fifteen (15) days after the delivery of the goods. Indications of performance, speed, consumption power, weight etc. are only given on an indicative basis and without any commitments or guarantees on our side, any inaccuracies may in no case give rise to the termination of an order or a request for compensation.

II.2. Our products are aimed at professionals, and as such should only be handled by individuals who have received free training on the product offered to the Customer by Hexagone Manufacture S.A.S. or its accredited distributor. Our pool cleaners are guaranteed against any material and construction defects for a period of twenty-four (24) months from the delivery date and for up to 1200 hours of use. Our devices other than pool cleaners are guaranteed for 12 months from the delivery date. Our warranty only applies to products which have become the property of the Customer.

II.3. We shall no longer be bound by our warranty obligation in cases where the warranty terms on some aspects of our products are breached without our express agreement.

II.4. Our warranty is limited to the replacement or repair of parts which we deem defective, excluding any other damages.

II.5. Hexagone Manufacture S.A.S. accepts no responsibility in cases of operating losses, loss of time or of any other indirect loss caused by its goods. The Customer must seek a substitute to defective equipment. Furthermore, the client shall comment on the usage scope of the equipment in case of defects observed on the material by themselves or in the place of use or on their mode of use.

II.6. All standard new or exchanged spare parts are guaranteed for 6 months for a maximum 500 hours of use.

II.7. Warranty on consumable parts. Filters, brushes, crawlers, belts, cables, trolley tyres are considered consumable parts, whose warranty is limited to 6 months and a maximum of 300 hours of use.

II.8. Exclusions to warranty in the following cases:

damage and wearing resulting from a special, abnormal or otherwise application or assembly, carried out by the Customer or a third party without prior and written agreement from Hexagone Manufacture S.A.S.; use of our goods in conditions of use or performance which do not conform with the technical specifications of Hexagone Manufacture

S.A.S., and more generally inappropriate or clumsy usage; damage or accident caused by the intervention of an employee of the Customer not trained to use the product or a company not accredited by Hexagone Manufacture S.A.S.; defects and/or damage to goods following maintenance not carried out in line with Hexagone Manufacture S.A.S. recommendations or failure to maintain, or irregular storage and/or conservation conditions by the Customer; whereby the Customer fails to notify Hexagone Manufacture S.A.S. in writing (specifically by fax or email) from the moment they observe the defect to the product under warranty and whereby they maintain in service a part or section of the defective product which may lead to further and more significant damage to the product or to the place of use. Malfunctioning as a result of normal wearing (e.g.: snapped belts, dead remote control batteries, bare brush-heads, etc...) or linked to problems with linings of and/or to specific shapes of pools which do not conform with the specification table required by Hexagone Manufacture S.A.S.; breakdown as a result of incorrect electrical installation, current fluctuations, poor connections or even the failure to observe by the Customer the electrical standards in force in the country of use; damage caused by external accidents: fall, transportation, fire, flood, melting, blackout, short-circuit, as well as accidents such as shocks, power-cuts, the introduction of foreign objects and/or liquids (acid, cleaning product, chlorine, water, tropical rainfall, etc...); where a third party or the Customer themselves has opened the electric control box and/or the engine or pump or gyroscope without our written agreement. The anti-corrosion warranty does not apply to sulphuric water or that without daily cleaning with stainless steel clear water. As a result, Hexagone Manufacture S.A.S. shall not be held responsible for material damage or accidents suffered by individuals as a result of one of the cases listed above.

Shipping and returns costs incurred by the application of the warranty shall be borne by the Customer.

We accept no responsibility for damage caused to property due to our products following an equipment failure or a construction defect to equipment sold.

PLEASE NOTE

The length of warranty for the defective equipment or part under guarantee shall be extended by a duration equal to the time spent in our servicing department where this is longer than a week. Outside of warranty repairs are subject to an estimated charge of 150 Euros less tax. This amount is only due if the Customer turns down repairs. Any parts delivered by Hexagone Manufacture S.A.S. shall be invoiced at the moment of delivery. In cases of warranty claims, said defective piece shall be returned to Hexagone Manufacture S.A.S. within a month maximum for assessment and work. Beyond this time, we can no longer accept it. Hexagone Manufacture S.A.S. shall in no case be held solely responsible for the cleanliness of pools. It is therefore recommended that the Customer always have access to a substitute for a defective machine. If a technician from Hexagone Manufacture S.A.S. should establish that the breakdown is not covered by warranty, the technician may invoice for the uncovered problem in line with the current tariff. Following testing of equipment under guarantee whose defect has not been found during servicing, the Customer shall be billed for the time spent looking for the defect.

Mode of intervention: you can contact the technical service by calling 0134341155 or any other Hexagone Manufacture S.A.S. agency. For work done under warranty, equipment or parts may only be sent to the following address: Hexagone Manufacture S.A.S., 34 rue du Perouzet, 95100 Argenteuil, France, quality service.

To request work under warranty, the Customer must fill in a sheet authorising the work, including the device's serial number, the in-service date, the number of the replacement part, as well as observations regarding the defect observed.

III. INDUSTRIAL PROPERTY:

Any technical documents sent to our clients remain the exclusive property of Hexagone Manufacture S.A.S., the sole holder of intellectual property rights over these documents, and must be returned to us upon request. In accordance with laws currently in force, it is forbidden for customers to fully or partially reproduce our technical and commercial documents and to make any use of them which is liable to violate the industrial or intellectual property rights of our company. The Customer shall undertake not to divulge these to any third party.

IV. INTERNET

We reserve the right to ask for removal of our products from sale on a website which does not respect our commercial policy in terms of price and trading conditions.

V. TERMINATION CLAUSE

In cases where any one of the Customer obligations is not respected by the latter, sale may be terminated fully within rights, and goods returned to Hexagone Manufacture S.A.S. as it sees fit, without prejudice to any damages or interests which Hexagone Manufacture S.A.S. may assert to the Customer, within 48 hours after a formal notice which goes unanswered. In this case, Hexagone Manufacture S.A.S. is within its rights to seek a fixed rate of compensation of 15% of the total sale price from the Customer, as well as default interests and any legal fees incurred.

VI. PROFESSIONAL WASTE ELECTRICAL AND ELECTRONIC EQUIPMENT (EEE)

In accordance with the provisions in articles R543-195 and R543-196 of the Environment Code modified by Decree n° 2014-928 of the 19 August 2014, our Company has hereby joined the accredited eco-body LOXY at Parc d'Activité du Vert Galant 17 rue Antoine Balard – 95310 Saint-Ouen l'Aum ne (RCS Pontoise 482.644.952) with a view to ensuring the collection and treatment of professional waste electrical and electronic equipment.

VII. APPLICABLE LAW – ATTRIBUTION OF COMPETENCE

This contract is governed by French law. The application of the Vienna Convention on Contracts for the International Sale of Goods is specifically excluded. Any dispute relating to the forming, implementation or termination of contractual obligations between the parties which does not lead to an amicable settlement shall be referred to the French courts. In case of any dispute with professionals and/or merchants, this shall be referred to the TRIBUNAL OF COMMERCE OF PONTOISE within whose area of jurisdiction Hexagone Manufacture S.A.S.'s headquarters is situated, whatever the conditions of sale and mode of payment accepted may be, even in cases of incidental claims, warranty appeal or of more than one respondent, Hexagone Manufacture S.A.S. reserves the right to refer the case to the competent local jurisdiction where the Customer's headquarters are situated.

VIII. PARTIAL NULLITY

If one of the clauses or provisions of these GCS should be annulled or declared void by a definitive court ruling, such nullity or void nature shall be without prejudice to the other clauses and provisions, which shall continue to apply.

HEXA PÜLSE, FOR A TRANSITION ECOLOGICAL SUSTAINABLE



*ONE ROBOT PURCHASED = ONE TREE PLANTED

*on robots sold directly, excluding distributors



Région
Île de France



Youtube :

HEXAGONE MANUFACTURE Digital



Facebook :

Hexagone Manufacture



LinkedIn :

HEXAGONE MANUFACTURE



Instagram :

hexagonemanuture



www.myhexagone.com

1-5 Rue Michel Carré 95100 Argenteuil - France • Tél : +33 (0)1 34 34 11 55 • Fax : +33 (0)1 34 34 11 50 • E-mail : info@myhexagone.com

HEXAGONE
SPORT ROBOTICS

